



ATESS HPS 50/100/120/150

Hybrid energy system user manual

Shenzhen ATESS Power Technology Co.,Ltd

3rd floor, building 9, Henglong industrial park, the fourth industrial zone of Shuitian community,
Baoan district, Shenzhen, China

T + 86 755 2998 8492

E info@atesspower.com

W www.atesspower.com

Revised date:2022-05-17

Contents

1 Introduction

- 1.1 Contents
- 1.2 Target readers
- 1.3 Symbols

2 Safety instructions

- 2.1 Notice for use
- 2.2 Installation
- 2.3 Important note

3 Product Description

- 3.1 Energy storage system
- 3.2 Circuit diagram of the inverter
- 3.3 Layout of the main components
- 3.4 Operation mode and status
- 3.5 Function protection
- 3.6 Dimension
- 3.7 Packing information

4 Transportation and storage

- 4.1 Transportation
- 4.2 Inspection and storage

5 Products installation

- 5.1 Installation condition and requirements
- 5.2 Tools and spare parts required for whole machine installation
- 5.3 Mechanical installation
- 5.4 Electrical installation
- 5.5 Communication
- 5.6 ATS wiring
- 5.7 DG dry contact connection
- 5.8 Parallel connection

6 Pilot operation

- 6.1 Inspection
- 6.2 Commissioning

7 GUI instruction

- 7.1 LCD display screen introduction
- 7.2 LCD operation
- 7.3 LCD display information schedule

8 Operation

- 8.1 Power on steps
- 8.2 Pilot operation completion
- 8.3 General history failure table
- 8.4 Power off steps

9 Routine maintenance

- 9.1 Regular maintenance
- 9.2 Waste disposal

10 Appendix

- 10.1 Specification
- 10.2 ATESS Factory warranty
- 10.3 Maintenance and inspection checklist for running system
- 10.4 Maintenance and inspection checklist for shutdown system
- 10.5 EMS mode RS485 command

1 Introduction

1.1 Contents

This manual will provide detailed product information and installation instructions for users of the ATESS HPS series energy storage integrated inverter (hereinafter referred to as inverter) of Shenzhen ATESS power Technology Co., Ltd. (hereinafter referred to as ATESS). Please read this manual carefully before using the product and store it in a place convenient for installation, operation and maintenance. Users will not be informed of any modification of this manual by ATESS. The contents of the manual will be updated and revised constantly, and it is inevitable that there is a slight discrepancy or error between the manual and the real product, Please refer to the actual products that you have purchased. Users should contact their local distributors or log in to our website: www.atesspower.com to download and obtain the latest version of the manual.







1.2 Target readers

Qualification :

- Only professional electricians certified by relevant departments can install this product.
- The operator should be fully familiar with the structure and working principle of the entire energy storage system;
- The operator should be fully familiar with this manual;
- The operator should be fully familiar with the local standards of the project.

1.3 Symbols

In order to ensure the personal and property safety of the user during installation, or optimally efficient use of this product, symbols are used highlight the information. The following symbols may be used in this manual, please read carefully, in order to make better use of this manual.

	DANGER DANGER indicates a hazard with a high level of risk which, if not avoided, will result in death or serious injury.
	CAUTION CAUTION indicates there is potential risk, if not avoided, could result in equipment malfunction and property damage.
	Caution, risk of electric shock When battery bank connecting point are exposed, there will be DC voltage in the equipment DC side; and when output breaker is on, there is a potential risk of electric shock.
	Caution, risk of fire hazard Suitable for mounting on concrete or other non-combustible surface only.
	Protective conductor terminal The inverter has to be firmly grounded to ensure the safety of personnel.
	Risk of electric shock, Energy storage timed discharge Electrical shock danger exists in the capacitor; the cover shall be moved at least 5 minutes later after all powers are disconnected.

Safety instructions 2

2.1 Notice for use

Inverter installation and service personnel must be trained and familiar with the general safety requirement when working on electrical equipment. Installation and service personnel

- should also be familiar with the local laws and regulations and safety requirements.
- Read this manual carefully before operation. The equipment will not be under warranty if failing to operate according to this manual.
- Operation on the inverter must be for qualified electrical technician only.
- When inverter operating, don't touch any electrical parts except for the touch-screen.
All electrical operation must comply with local electrical operation standards.
Permission from the local utility company is required before installing the energy storage system and only professional personnel are qualified for the operation.

Product description 3

2.2 Installation

Proper installation requires following all the instructions in the user manual involving transportation, mounting, wiring and commissioning. ATESS does not cover warranty for the inverter damage due to failing to use it properly.

The protection level of the inverter is IP20, which is designed for indoor installation. Please refer to chapter 5 for installation instruction.

Other notice for using the inverter :

- Pay attention to the safety instructions listed here and below ;
- Pay attention to the user manual of energy storage controller ;
- Technical data related to equipment shall be considered.

2.3 Important note



Item 1 Static electricity can cause damage to the inverter electrostatic discharge may cause unrecoverable damage to inverter internal components!
When operating the inverter, operator must comply with anti-static protection norms!

Item 2: Restriction

The inverter cannot be directly used to connect the life support equipment and medical equipment!

Item 3: Precautions

Make sure installation tools or other unnecessary items are not left inside the inverter before starting up.

Item 4: Maintenance notice

Maintenance can only be carried out after the inverter totally discharged.

3.1 Energy Storage system

ATESS HPS bidirectional battery inverter is designed for energy storage system, it converts DC current generated by battery bank into AC current and feed it into the load/grid, also it can take power from solar inverter or grid to charge battery to ensure uninterrupted power supply to the load.

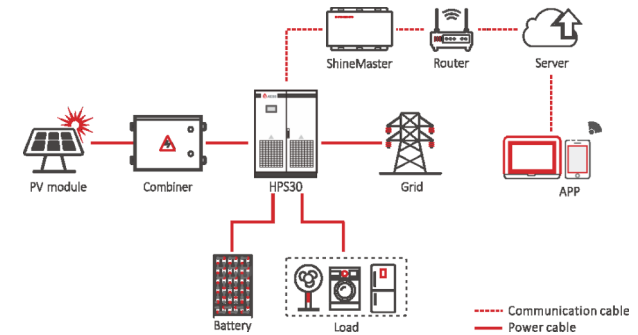

3.2 Circuit diagram of the inverter

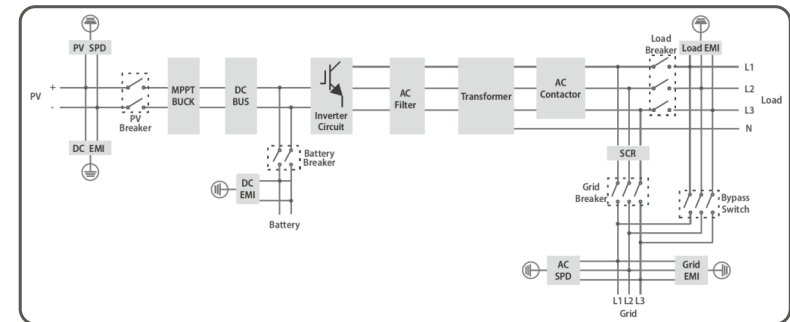

3.3 The layout of the main components

3.3.1 External components

The main external components of the energy storage controller include: LED indicator, LCD touch screen, off-on knob, emergency stop button and other parts.

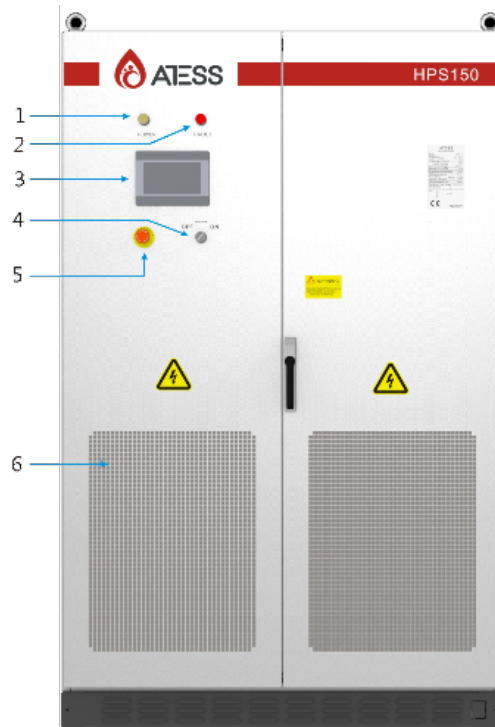

Appearance description of energy storage inverter

NO	Name	Description
1	Power indicator	When power supply is normal, the indicator displays yellow.
2	FAULT	When inverter is faulty, the indicator displays red.
3	Touch Screen LCD	Operation information display, receive control command and parameters setting
4	OFF/ON knob	Only control the grid-side switch, and does not control the DC-side switch
5	EMERGENCY STOP	Shut down the inverter when pressed down
6	Dust screen	Prevent dust from entering into the inverter

Part description

> Indicator

The energy storage controller adopts intelligent design. There are two LED indicators on the inverter which is used to display the current status of the inverter.



LED	Description
POWER	The indicator lights when power supply to the inverter is normal.
FAULT	The indicator lights when there is failure in circuit system.

> Emergency STOP

The emergency stop button is only used in case of emergency, such as: serious failure in the grid, fire, etc.



Emergency STOP

The emergency stop button immediately disconnects the inverter from both grid and battery, which ensure the safety of the inverter. By pressing the emergency stop button, the device will be locked in the "off" position. Only release the emergency stop button by rotating it clockwise and closing AC, DC breaker, can the inverter resume working normally.

> Off-on knob

It is used to start or stop the inverter.



Off-on knob

Please read Section 8 "operation" for detailed switch on / off process.

> Touch screen

It displays the inverter's operating parameters, power generation, and faulty information record. Please refer to Section 7 for details.

3.3.2 internal component

The internal components of the energy storage inverter include: PV circuit breaker, battery circuit breaker, power grid circuit breaker, maintenance switch, load circuit breaker, power supply micro break, AC lightning protection switch, PCB, etc.

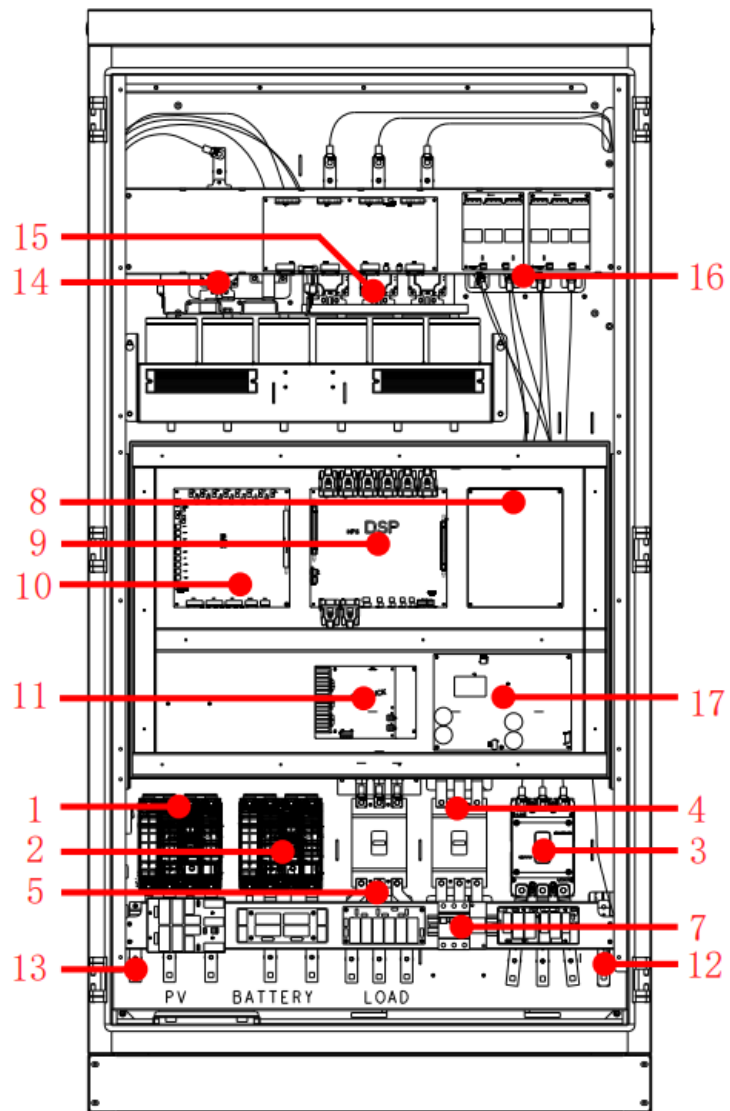

The front structural drawing of hps50

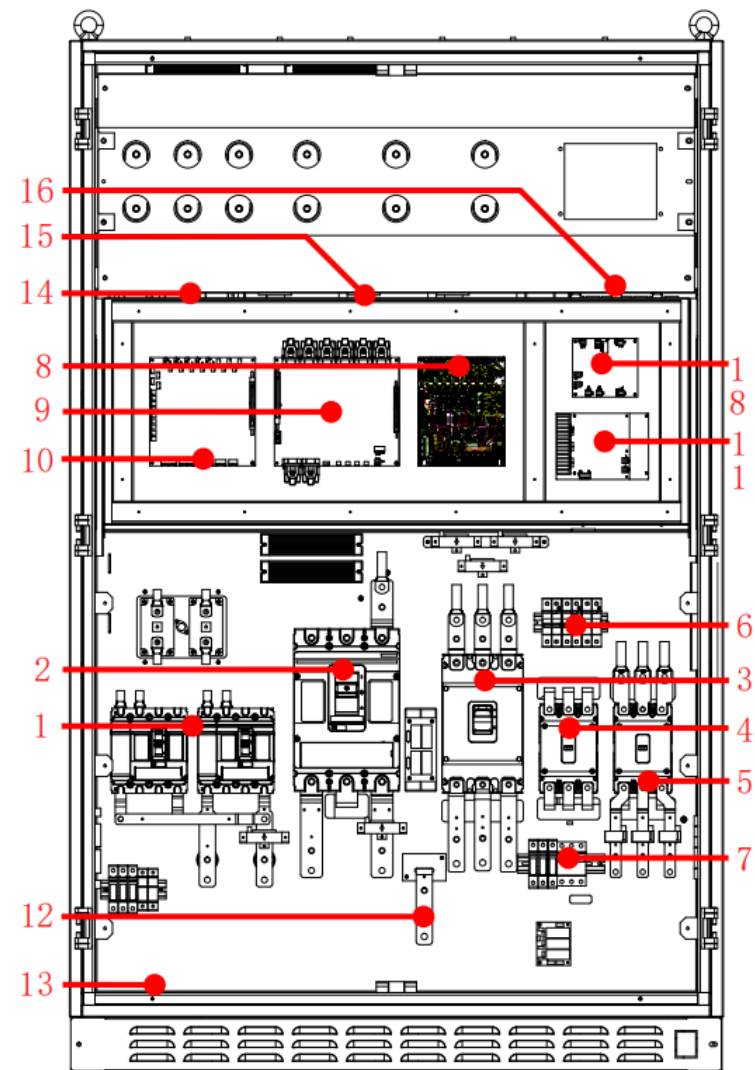

The structural layout of HPS100/120/150 is basically the same, please pay attention to the printing on machine.

NO	Name	Description
1	PV input	Control the connection of battery and HPS
2	Battery input	Control the connection of battery and HPS
3	AC input	Control the connection of grid and HPS
4	BYPASS	Maintenance switch, see 9.1.3 for details
5	AC output	Control the connection of load and HPS
6	Power supply micro break	power board, fan power switch
7	AC lightning protection switch	Switch for AC lightning protection
8	Interface board	inverter power supply conversion PCB
9	Control board	inverter main control board, with communication interface
10	Sampling board	voltage current temperature sampling PCB
11	BUCK board	DC power supply PCB
12	N terminals	Load and grid N terminals
13	Earth terminals	Grounding bronze terminals
14	IGBT1	PV side IGBT
15	IGBT2	Inverter side IGBT
16	SCR	Control on/off grid switch
17	24V power board	24V power board of the inverter
18	Rectifying board	PCB for AC power supply and AC/DC power supply converting

3.4 Operation mode and status

Please refer to Section 7.2.4 for details on operation mode setup procedure.

Caution!



Before the machine leaves the factory, the operation mode will be set according to the technical agreement. ATESS will not be responsible for the consequences caused by modifying the operation mode without the consent of ATESS. Please contact ATESS personnel for modification if needed.

3.4.1 On grid mode

Optional functions in grid connection mode:

Anti-backflow enable

1. When anti-backflow enable is set to 1, feeding power to utility grid is restricted.
2. When anti-backflow enable is set to 0, HPS can feed power to utility grid.

Grid&PV charge together enable

1. When simultaneous charging function enable is set to 1, grid and PV can charge battery simultaneously.
2. When simultaneous charging function enable is set to 0, grid and PV can not charge battery at the same time.

Please refer to Section 7.2.4 for setup procedure.

3.4.1.1 Load first mode (anti-backflow function optional)

1. When PV energy is sufficient, PV supply priority to load, the remaining to battery.
2. When the PV power is not enough for the load, the battery will discharge automatically. If the battery discharges to the stop discharge set point, the battery will stop discharging and the load will be powered by PV and the grid. To protect the battery, the battery will be charged with a small current. When the battery is charged to a recoverable discharge state, the discharge will be resumed.

Stop discharge set point: refer to chapter 7.2.4 for the setting of discharge cut-off voltage, discharge cut-off SOC, etc.

Recovery discharge set point: Battery saturation, recovery discharge SOC and other settings. See Chapter 7.2.4 for details.

3.4.1.2 Battery first mode (anti-backflow function optional)

1. When the PV energy is sufficient, PV supply priority to battery charge, the remaining to load;
2. When PV energy is insufficient, PV charge the battery first, the power grid will supply the load and charges the battery at the same time;
3. If the grid connected backup mode is not discharged or switched to other modes, To maintain electrochemical activity, the battery will enter the discharge state after one week of current limiting charging, and the discharge power will be calculated according to battery specifications.

3.4.1.3 Time shifting mode(anti-backflow function optional)

The period of economic mode is divided into peak period, fair period and valley period. Please refer to section 7.2.4 for the setting details.

1. Valley price: working logic is the same to the backup priority mode's.
2. Fair price:
 - A. Battery can neither discharge nor be charged by grid.
 - B. PV power supply priority to load, the remaining to battery when PV power is higher than load.
 - C. When PV power is lower than load power, PV and grid supply load, PV doesn't charge battery.
3. Peak price:
 - A. Grid will not charge battery.
 - B. When PV power is higher than load, PV supplies to load , the remaining to battery.
 - C. When PV power is lower than load power, there are two conditions:
 - (1) The battery state does not reach the stop discharge set point, and the PV and battery output are supplied to the load;
 - (2) When the battery state reaches the stop discharge set point, the battery stops discharging, PV and the power grid jointly supply the load and do not charge the battery.

3. When (PV power + upper limit power of power grid) is greater than the load power, grid and PV supply priority to the load and the remaining charge batteries.

4. When (PV power + grid upper limit power) is less than the load power, the grid, PV and battery supply the load at the same time.

3.4.1.5 EMS MODE

Description:

1. In EMS mode, the energy storage controller is controlled by EMS management system, has no operation logic, and the power is controlled by EMS command;
2. The power transmitted under EMS mode is still limited by the screen setting value;
3. It needs to be used with EMS;
4. the controlled power includes PV power and inverter rectifier power (only PV power can be controlled when it is not connected to the power grid, and the inverter power can be automatically adjusted according to the load conditions). When it is set as inverter, DC is output to AC. when it is set as rectifier, AC charges the battery. See the control instructions below for details.

Control Description:

No.	Diagram	Description
1	<p>All PV power charge to battery, DC-AC rectifier power remains 0</p>	<p>Keep the DC-AC rectifier power at 0, only modify PV power, at this time, PV is fully charged and AC has no power</p>
2	<p>PV power remains 0, all the DC-AC power send to AC</p>	<p>Keep PV power at 0, only modify the DC-AC power, at this time, the battery inverts to AC</p>

No.	Diagram	Description
3	<p>PV power remains 0, all rectifier power charge to battery</p>	<p>Keep PV power at 0, and only modify the rectifier power. At this time, the AC charge battery</p>
4	<p>PV power DC-AC power</p>	<p>PV power higher than or equal to inverter power, PV convert to AC in priority, remaining charge to battery</p>
5	<p>PV power < DC-AC power</p>	<p>PV power lower than DC-AC power, PV and battery output to AC together</p>
6	<p>PV power + rectifier power charge to battery</p>	<p>PV and AC power charge battery together, when PV+AC power exceeds the max. charging value, use PV power to charge battery in priority</p>

3.4.2 Off-grid mode

1. When there is no power grid or the DG is connected, the inverter will automatically switch to off grid mode.
2. In off grid mode, when the PV energy is sufficient, the PV will power the load first and charge the battery.
3. In off grid mode, when PV energy is insufficient, the battery will automatically discharge and supply the load.
4. When the power grid or DG is restored, the inverter will automatically switch to on-grid mode or DG mode.

3.4.3 DG mode

1. In off grid mode, if the inverter is connected to the DG and the DG enable is set to 1, when the battery discharges to the stop discharge setting point, the inverter sends a dry contact signal to start the DG. After the DG is successfully connected, it enters DG mode. Now the DG supplies power to the load; Meanwhile, the inverter stops supplying power to the load and only charges the battery.

2. When the battery reaches the preset point of stopping DG, the inverter will stop the dry contact signal, the DG will be switched off and inverter will switch to off-grid mode.

- Start the DG set point: SOC lower limit, discharge cut-off voltage, see Chapter 7.2.4 for details
- Turn off the DG set point: SOC upper limit, floating charge current limit point settings. See Chapter 7.2.4 for details.

3.4.4 PV charge

1. When utility is unavailable, turn on the knob without clicking the LCD power-on key, HPS will start to enter PV charge, then PV only charges the battery and will not invert AC output.
2. When utility is unavailable, manually start the LCD screen in PV charge, then inverter enters off grid mode.
3. In the off grid mode when discharged to the battery low voltage alarm point, inverter will stop DC/AC converting and automatically switch to PV charge. When battery is charged to the set voltage(PV charge to off-grid), it automatically switches to off grid mode.
4. In PV charge mode, when it detects the access of power grid or DG, the inverter will automatically enter on-grid or DG mode.

See Chapter 7.2.4 for details on charge change to offline.

3.4.5 Automatic on/off grid switch

Operate logic: when the power grid is normal, cut the grid automatically, otherwise when the power grid is abnormal, cut off the grid automatically.

3.4.6 Fault mode

When the inverter fails, the contactor on AC and DC sides will immediately disconnect and shut down the inverter, so as to ensure the system safety. At this time, the inverter will continuously monitor whether the fault is eliminated, If not, it will maintain the fault state; after eliminated, it will restart automatically.

3.4.7 Permanent failure mode

When the inverter has a serious fault, the contactor on AC and DC sides will immediately disconnect and enter a permanent fault state to ensure safety of the system. When permanent fault is detected three times in a row, all switches will be disconnected. For example, the IGBT module of the inverter is faulty. When inverter enters this permanent failure mode, please do not repair it without permission. You should contact the personnel of the local dealer or call Shenzhen Ates Power Technology Co., Ltd. for help.



When temperature gets too high, output power of the inverter will decrease, which is normal. However, if this happens frequently, check the cooling surface of the inverter or place it in a place with good ventilation condition. If the fan gets dirty, please clean the dust on it. If there is any problem inside the inverter, please contact the professional service department for help.

3.5 Function protection

Anti-islanding protection

When the local power grid is shut down due to fault or equipment maintenance, the HPS will physically cut off the connection with grid in order to protect the operators working on the power grid, the HPS fully meets the relevant national standards.

Lightning protection

The HPS has built-in lightning protection module, with DC / AC over-voltage lightning protection, to avoid being struck by lightning. For more protection functions, please refer to Section 7.3.

3.6 Dimension

Model	HPS50	HPS100	HPS120	HPS150
Dimension (W*H*Dmm)	950/1860/750mm		1200/1900/800mm	
Weight(KG)	620	900	1024	1250

Figure--Dimension and weight of HPS

3.7 Packing information

NO	Name	Unit	Qty.	Note
1	HPS	unit	1	Key included
2	User manual	pcs	1	
3	Certificate	pcs	1	
4	Factory test report	pcs	1	

Figure--Packing information

Transportation and storage 4

4.1 Transportation

Transportation should follow the transportation methods described in the user manual. The inverter's weight and center of gravity should be taken into account during transportation. The center of gravity is marked on the box.



Caution, risk of danger

During transportation, lifting equipment and personnel must be qualified. The inverter should be placed vertically and the inclination cannot be more than 10 degrees. It is not allowed to place the inverter upside down or transport in a horizontal position. Incorrect lifting and transportation can lead to serious injury, property loss and damage to the inverter.

4.2 Inspection and storage

The inverter should be carefully checked before signing the document from the transportation company. Check the received items against delivery note, and if there is any defect or damage, immediately notify the transportation company. If necessary, you can seek help from Ates Customer Service department.



Caution

ATESS HPS50 can only be stored when it is stopped and all the doors are closed in a dry room to protect the internal circuits against dust and moisture.

5 Installation

5.1 Installation condition requirements

To ensure normal operation of the machine, the installation environment is required as follows:

- > The ingress protection of inverter is IP20. Moreover, as this product is an electronic equipment, it shall not be placed in humid environment;
- > Install indoors and avoid sunlight and rain;
- > Ventilation of the room shall be good;
- > The installation environment shall be clean;
- > As some noise will be produced in operation, this equipment shall be installed far from residential quarters;
- > The installation ground shall be even enough, and firm enough to support the weight of inverter;
- > The installation position shall be convenient for maintenance;
- > Ambient temperature range: $-25^{\circ}\text{C} \sim 55^{\circ}\text{C}$;
- > Appropriate space shall be reserved for the machine to ensure ventilation and cooling.

We suggest inverter is installed in the distribution room. The floor, wall clearance, Ventilation equipment and precaution should be designed by professional personnel and satisfy the following requirements.

> Foundation requirement

Inverter is required to install on even ground with fire-retardant material as the surface or channel steel support structure, and sag or tilt ground is prohibited. The foundation shall be solid, safe and reliable. The foundation shall be capable of bearing the load of the inverter. Its load bearing ability shall be concerned throughout the installation place selection.

> Clearance space

During installation of the inverter, appropriate space shall be left to the wall or other equipment, in order to satisfy the requirements on narrowest maintenance channel, emergency access and ventilation.

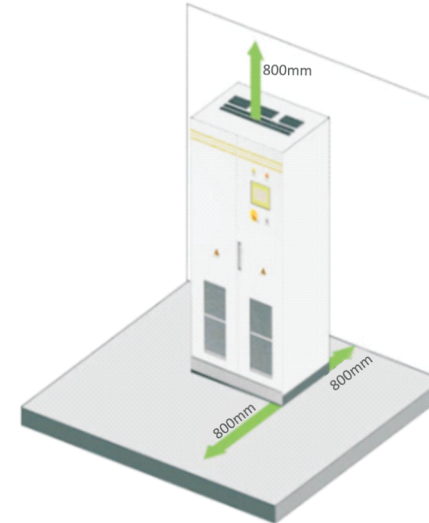

In front of the installation place of inverter, a space of 0.8m or more shall be ensured, the back 0.8m or more, the top 0.8m or more to ensure easy installation, cooling and maintenance.

> Cable trench

The cable connection of inverter adopts bottom inlet and bottom outlet. Cable trenches are recommended to ensure easy installation and maintenance.

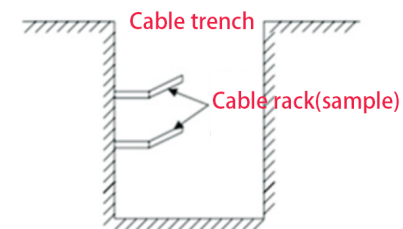

The cable trenches are often designed and constructed by the construction side based on relevant standards, with the equipment weight and dimensions required to be considered. Good electrical connection is needed between different cable trenches and GND terminals.

> Wiring specification

Cables in the inverter can be classified into either power cables or data cables. In cabling, the power cable shall be kept far away from, and the cable shall be kept in right angle at cross. The cable shall be as short as possible, and an appropriate distance shall be kept to the power cable. It is recommended that the insulation impedance of BT + and BT - at DC end to ground to be higher than 1m

The power cable and data access shall be placed in different cable trenches respectively to avoid lengthy routing between the power cable and other cables, so as to reduce the electromagnetic interruption caused by sudden change of the output voltage. The distance among the power cable and data access shall be more than 0.2m. When the cables are crossed, the cross angle shall be 90 degrees, while the distance can be reduced appropriately.

> Ventilation requirement

In operation, inverter will produce a lot of heat. When ambient temperature is too high, the electrical property of the equipment may be affected, the equipment may even be damaged. Therefore, the heat release shall be fully considered in designing the control room to ensure operation of the equipment in high efficiency.

> Ventilation environment

To satisfy the ventilation requirement of inverter, its installation environment shall meet the following conditions:

- ※ Inverter shall be prevented from being installed in the place of poor ventilation condition and insufficient air flow;
- ※ The air inlet shall have enough air supplementation.

> Ventilation equipment

To ensure safe and reliable operation of the equipment, the ambient temperature must be within the permission range $-25^{\circ}\text{C} \sim 55^{\circ}\text{C}$, therefore, appropriate ventilation devices must be equipped with to release the heat generated by the equipment.

1. There must be ventilation equipment inside the distribution room to ensure release of the waste heat generated by the inverter from the equipment, and allow for maximum ambient environment temperature. This can be realized from installation of exhaust devices;
2. Another fan can be added at the air duct outlet to exhaust the air out and ensure balanced pressure;
3. The direction of the air outlet shall be selected according to the local actual wind direction;
4. Pay attention to the dustproof measures and waterproof design at the air inlet and outlet;
5. If more air ducts are required, its dimensions shall be designed by the professionals according to the air output amount.

> Other protections

With IP20 of protection level, inverter is appropriate to be installed in dry and clean environment. Meanwhile, water leakage of the house shall be prevented, as it may damage the inverter. According to EMC requirement and noise level, the inverter shall be installed in industrial environment.

5.2 Tools and spare parts required for whole machine installation

Tools and spare parts required for installation is as follows:

- > Hoisting crane, forklift or fork lift truck (with the capacity for bearing the weight of the inverter)
- > Torque wrench
- > Screwdriver
- > Wire stripper
- > Terminal crimping machine
- > Heat dryer
- > Megger and multimeter

5.3 Mechanical installation

5.3.1 Transportation of packaged whole machine

This inverter is transported as an integrated unit, and the user can hoist it from the bottom with a forklift, or move it with a hoisting crane or crane.

Note 1: The inverter is integrated and cannot be disassembled either in transportation or installation. Any fault attributed to modification unauthorized by the ATESS is beyond the quality assurance.

Note 2: In movement, tilt, violent shake or sudden force upon the inverter shall be prevented, such as sudden down of lifting.

Note 3: Please read carefully the labeled parameters to select an appropriate transportation means and storage place.

We suggest the user make use of forklift to move the inverter if possible.



Before the inverter is moved to the designated place, we suggest to lay the DC input cable and AC main power supply cable. As these cables are relatively thick, they are hard to be cabled after the inverter is installed.

To keep the equipment in a better protective status, please adopt transportation with package as much as possible, and comply with the labels printed on the package in transportation :

Sign	Indication
	The gravity centre
	Lifting logo
	Face up to prohibit the inverter horizontally, tilted or upside down
	Handle with care, to avoid the transport environment too intense collision friction damage to the inverter
	Keep away from moisture

Inverters whose packages are not demolished can be moved with forklift, hoisting crane or crane. In moving, attention shall be paid to the weight painted on the package to ensure enough load capacity of the devices. As the gravity center of the equipment locates at the lower place symmetrical in front and back and left and right, the support point or hoisting point shall be arranged reasonably in transportation. The forklift transportation is the standard one. The gravity center of the cabinet in transportation should locate between two forks of the forklift. The big-size inverter may block driver's sight, and it shall be treated with cooperation of the aid personnel.

5.3.2 Movement and installation of bare machine

> Demolish the package of inverter

Please demolish the packaged cabinet of the equipment according to the following procedures:

Procedure 1: Demolish the wood side and roof of the packaged cabinet

Procedure 2: Demolish the out-set package material on the machine

Procedure 3: Demolish the fastening screws between the machine and the pallet

- ① Demolish the front and back cover lids of the pedestal;
- ② Screw off the hold-down nuts at the bottom of the wood pallet;
- ③ Remove the screws, and the inverter will depart from the wood pallet.

> Movement and installation of bare machine

The inverter with demolished package can be moved with forklift, hoisting crane, slide rail or crane. If the package demolished place is far from the final installation place, it can be transported with forklift containing wood pallet.

If the wooden pallet at the bottom of the machine has been removed, when using the forklift, the front and rear cover plates of the base need to be removed first, and the center of gravity should be placed in the middle of the two forklifts, and then start lifting and transporting, as shown in the following figure:



Caution, risk of danger

We must act slowly and gently when transporting the inverter with forklift to avoid violent vibration of the inverter or collision with other objects.

If lifting method is used for moving, please pay attention to the lifting position, ensure that the lifting angle is 70°, and be cautious of the center of gravity position of the inverter.

NOTE:

- > It is necessary to always pay attention to the position of the center of gravity of inverter.
- > Take necessary auxiliary measures to ensure the safety of transportation personnel;
- > Take necessary auxiliary measures to ensure that the equipment is delivered to the final installation site.

5.4 Electrical installation

5.4.1 Input and output requirements



Caution, risk of danger

> There is a danger of electrical shock of high voltage in inverter's operation; only electricians of professional skills can operate.

> All connections with this equipment shall be done under non-voltage state.

> The inverter may be damaged if input or output terminal is incorrectly plugged.

Failure of acting upon this information may cause serious personnel injury or significant property loss even to death.

> Battery

The battery operating voltage is 352V-600V. The battery voltage should be not lower than 352V and not higher than 600V.

> PV module

The maximum MPPT working voltage of PV module should not be more than 820V and the open circuit voltage should not exceed 1000V, otherwise the equipment will be in over-voltage protection state and cannot work normally. The MPPT voltage range of should be within 480V-800V, which means the minimum PV working voltage shall not be lower than 480V. And under the rated power, maximum working voltage shall not be higher than 800V.

> PV and battery configuration

The MPPT voltage shall be greater than the maximum voltage of the battery, otherwise, the battery cannot be fully charged by PV power. However, it is suggested that the voltage difference not be too large, or it will speed up the machine wearing and the reduce efficiency. The best configuration is that the voltage of MPPT is 100V higher than the maximum battery voltage.

> Three phase grid connection

The inverter will constantly detect whether the power grid meets the grid connection conditions. The grid connection requirements of various countries may be different. The protection parameters of the inverter can be set. For details, please refer to the local grid connection regulations. The power grid is a three-phase power grid. Plus, the installation shall be approved by the local power department.

Model	50/100/120/150
Grid voltage limit	360V-440V
Grid frequency limit	45Hz-55Hz/55Hz-65Hz

> Cable requirements

1. Please select the corresponding withstand voltage cable according to the voltage level.
2. Because different voltage will lead to change of current, please calculate the corresponding cable diameter according to the actual voltage range. The following table only provides the cable requirements of the lowest working voltage and rated power. In actual application, it should be calculated according to the actual voltage, please inquire the after-sales staff of ATESS if you need more details.

Cable Model	Cable Diameter Requirements (mm ²)				Aperture	
	HPS50	HPS100	HPS120	HPS150	HPS50	HPS100/120/150
	Bellow are total line diameter					
PV	50mm ²	70mm ²	95mm ²	120mm ²	Φ8	Φ10
Battery	50mm ²	120mm ²	120mm ²	150mm ²	Φ8	Φ10
Utility	70mm ²	120mm ²	120mm ²	150mm ²	Φ8	Φ10
Load	35mm ²	70mm ²	70mm ²	95mm ²	Φ8	Φ10
N wire	70mm ²	120mm ²	120mm ²	150mm ²	Φ8	Φ10
Earth wire	More than 16 mm ² .Green and yellow is recommended				Φ8	Φ8
Communication Wire	0.75mm ² , shielded communication line is recommended				/	

5.4.2 DC side wiring



Caution, risk of danger

The positive and negative of the battery shall not be connected in reverse. A multimeter shall be used to determine the polarity first, and then connect into the corresponding input ends of the battery.

Specific procedures are as follows:

- 1) Cut off the distribution circuit breaker at the DC side, and ensure that no voltage on the wire at DC side.
- 2) Use a multimeter to measure the open circuit voltage of the battery to ensure that it is within the allowed range.
- 3) Determine the positive and negative pole of the battery with a multimeter.
- 4) Strip off the insulation skin at the end of the cable.
- 5) Crimp the wiring copper nose.
 1. Put the stripped copper core into the crimping hole of the copper nose.
 2. Use the terminal pressing machine to press the copper nose tightly. The number of crimping shall be more than two.
- 6) install the shrink fit sleeve.
 1. Select the heat shrinkable sleeve which is more consistent with the cable size, length is about 5cm.
 2. The heat shrinkable sleeve shall be sleeved on the copper nose of the wiring to completely cover the wire pressing hole of the copper nose.
 3. Use a heat blower to tighten the heat shrink sleeve.
- 7)Connect the positive of the battery to the "Battery-input +" of DC input
 1. Select the bolts that match the copper nose.
 2. Connect the copper nose at both ends of the wiring firmly to the "battery input +" end of the inverter and the positive pole of the battery.
 3. Tighten the bolts with a screwdriver or wrench.
- 8)Connect the "battery input -" end of the inverter to the negative pole of the battery by cable according to the method of step 7.
- 9)cable the "PV input +" end of the inverter to the positive pole of the PV module according to step 7.
- 10)cable the "PV input -" end of the inverter to the negative pole of the PV module according to step 7.
- 11) Please be sure that all wirings are fastened.

5.4.3 AC side wiring



Caution, risk of danger

When connecting the AC grid, cut off the circuit breaker at the AC side to ensure that the AC wire connecting to terminals has no electricity.

The output voltage of the AC side of the inverter is 400V, which is connected to the power grid through a transformer. The wiring method of AC side and grid side is as follows:

- 1) Cut off the circuit breaker at AC side, to ensure that the AC wire connecting to terminals has no electricity. Confirm it with a multimeter.
- 2)Ensure that the wiring phase sequence at AC side is in consistent with the phase sequence at grid side.
- 3)Strip the insulation skin off at the end of the cable
- 4)Crimping copper nose
 1. Put the exposed copper core of the stripped wire head into the crimping hole of the copper nose.
 2. Use the terminal crimper to compress the copper nose of the wiring, and the number of crimping shall be more than two.
- 5)install the shrink fit sleeve.
 1. Select the heat shrinkable sleeve which is more consistent with the cable size, length is about 5cm.
 2. The heat shrinkable sleeve shall be sleeved on the copper nose of the wiring to completely cover the wire pressing hole of the copper nose.
 3. Use a heat blower to tighten the heat shrink sleeve.
- 6)Connect "L1" cable to "L1" of AC distribution cabinet, i.e. phase a (U). Select the bolts that match the copper nose.
- 7) connect "L2" of AC output to "L2" of AC distribution cabinet, i.e. phase B (V); connect "L3" of AC output to "L3" of AC distribution cabinet, i.e. phase C (W); connect n-line to n wire on the inverter.

5.4.4 Earthing

Inverter must be earthing well for safety; Please make sure of the connection between PE in power distribution cabinet and PE copper in the inverter good; and make sure the earthing cable more than half of load cable, and earthing resistance is not lower than 4Ω.

All wiring into the channel at the bottom of the inverter to be all the wiring is completed, the connection port must be sealed with dust cotton, to prevent dust from entering the inside of the inverter.



Connect several connecting wires on the PE copper bar as some parts inside the energy storage controller need to be grounded, please do not change them without permission, so as to avoid electric shock

5.5 Communication

The HPS adopts various communication modes. The figure below is the diagram of the communication port of the control board.

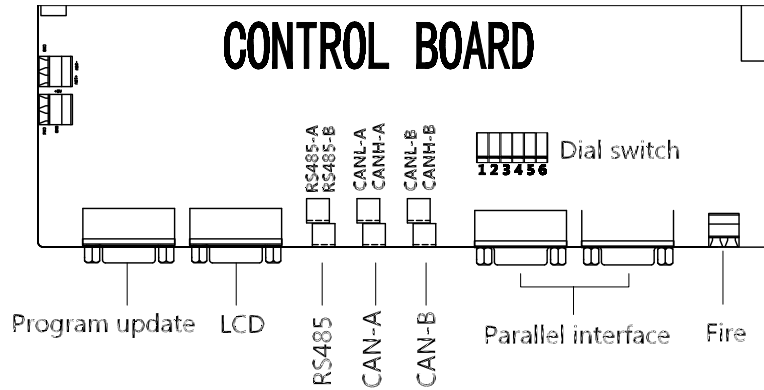

Description of dial switch:

The dial switch is a connection control switch with communication matching resistance (120 Ω). "On" indicates connection resistance and "off" indicates no connection with the resistance.

No.	Name	Description
1	485	485 matching resistance
2	CANA	CAN matching resistance
3	CANB	CAN matching resistance
4	M-S	Parallel matching resistance
5	ON-OFF	
6	M M S	

1. RS485 communication

- Multiple inverters communicate with each other through RS485 line, and finally transmitted to the monitoring server through the Shinemaster / Enerlog via Ethernet, which can remotely monitor the operation status and data of single / multiple inverter(s) in real time. Both ends of the RS485 communication line are connected with terminals, and the terminals at both ends are connected in parallel. The length of the line shall not exceed 1000m. It is recommended to use a special shielded communication line.
- The RS485 interface of the inverter is located on the internal control board of the machine. Please distinguish "A" and "B". The wrong connection will lead to communication failure.
- If Shinemaster / Enerlog is not used for monitoring, the user's own monitoring equipment needs to be compatible with the RS485 communication protocol of ATESS.
- For the same 485 bus, only 120Ω matching resistance needs to be connected from end to end. Please set the dial switch according to the field installation.



2. BMS-CAN communication

- When the HPS works with battery with BMS management system, it needs to communicate with BMS through CAN communication. The CAN communication interface of BMS is connected to CAN-A interface of the HPS, communication can be realized after docking the communication protocol.
- Terminals are used at both ends of the CAN communication line. The terminals at both ends are connected in parallel to make the can communication line. It is recommended to use a special shielded communication line to reduce communication interference and improve the operation stability of the system.
- The CAN-A interface is on the internal control board of the inverter. Please distinguish between "L" and "H". Incorrect connection will lead to communication failure.
- If the user does not use the BMS battery system produced by ATESS, the user's own BMS battery system needs to be compatible with the BMS communication protocol of ATESS.
- For the same CAN bus, just connect 120Ω matching resistance from end to end. Please set the dial switch according to the field installation.

3. ATS-CAN communication

- When the inverter is used with ATS, They need to communicate with each other, and the CAN communication interface of the ATS is connected to the inverter's CAN- B interface. Note: only the ATS produced by ATESS can communicate with the HPS.
- The ATS produced by ATESS is equipped with a special communication line for communication with the inverter.
- The CAN-B interface of the inverter is on the internal control board of the inverter. Please distinguish between "L" and "H".
- When the inverter is used with the bypass cabinet, it needs to communicate with the bypass cabinet, and the CAN communication interface of the bypass cabinet is connected to the inverter's CAN- B interface. Note: only the bypass cabinet produced by ATESS can communicate with the HPS.
- The bypass cabinet produced by ATESS is equipped with a special communication line for communication with the inverter, which can be directly connected to the CAN-B interface of the inverter.
- The CAN-A interface of the inverter is located on the internal control board of the inverter. Please distinguish between "L" and "H". Incorrect connection will lead to communication failure.
- For the same CAN bus, just connect 120Ω matching resistance from end to end. Please set the dial switch according to the field installation.

3. Parallel communication (special for customized parallel function)

- Parallel communication is required when two same HPS models are used in parallel.
- DB9 communication line is used for parallel communication, which goes with the shipment in parallel scheme, also there will be special parallel communication interface.
- When paralleling two HPS models, DB9 communication line is used to connect the parallel interfaces of two models. One of the two parallel interfaces on the control board can be selected as the reserved interface.



As Parallel function is a special customized function, please use it under the guidance of ATESS staff.

5.6 ATS wiring

When the system needs to be connected to utility grid and generator at the same time, an ATS is required to be used together with HPS, which is mainly used to switch between the utility and generator.

2. The main wiring of ATS and HPS is ATS internal panel power line, CAN communication line and AC power line.

Wiring diagram is shown as below:

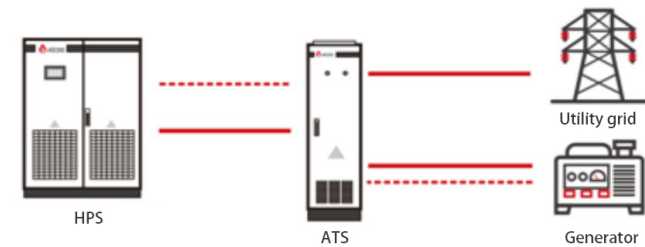

3. There are three circuit breakers in ATS. The middle circuit breaker is connected to the power grid switch (AC input) of HPS. The other two are grid switch (grid) and generator (Gen) switch. Pay attention to the printing on cabinet. It is not allowed to connect incorrectly, neither is it for the three phase sequence, otherwise the system cannot operate normally.

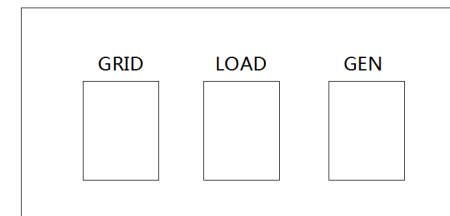

4. ATS needs to communicate with HPS, which is connected on CAN-B of HPS. Pay attention to the sequence and distinguish "L" and "H".

5. ATS needs to be powered by HPS and connected to CN3 of the BUCK board of HPS. Pay attention to positive and negative, red is positive and black is negative.

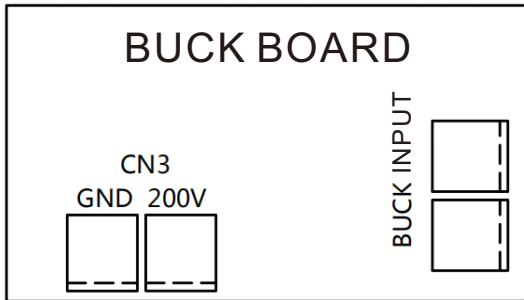

When the ATS of other manufacturers are applied CAN communication mode cannot be used to distinguish the generator and power grid. They can be distinguished by connecting passive dry contact signal (it is suggested that the switchover time for ATS to switch between generator and grid should be more than 5 seconds to ensure the correct mode switching of the inverter). Connect the signal line to the CN14 port of the energy storage inverter's interface board. It's default that open signal means connecting the power grid, and close signal means connecting to generator.

5.7 Diesel generator dry contact wiring

The inverter has a passive dry contact contactor to control the diesel generator, and the following is the dry contact structure diagram (initial state).

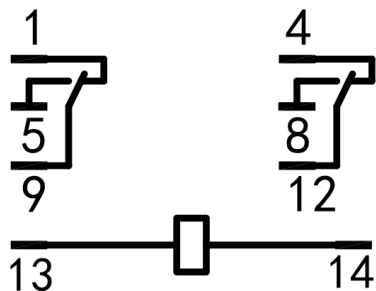

Wiring instructions:

- "13" and "14" are the power supply of dry contact contactor, no need for wiring.
- There are two groups of connection contacts in the dry contact, "1", "5" and "9" are a group, "4", "8" and "12" are a group, and the two groups will act at the same time.
- The initial state is that when the inverter does not send the command to start the diesel generator, the state between "1" and "9" means stay closed, and the state between "5" and "9" means stay opened. When the inverter sends the command to start the diesel generator, "1" and "9" are switched to stay opened from stayed closed, and "5" and "9" are switched to stay opened from stayed closed. "4", "8" and "12" are the same.
- When the current needs to pass through the dry contact, the AC voltage shall not exceed 240V, the DC voltage shall not exceed 28V, and the current shall not exceed 5A.

5.8 Parallel wiring

> Parallel operation system:

- Two same HPS models are used in parallel, output and supply load at the same time operating in the same mode.
- Parallel operation means in off-grid parallel mode, multiple energy storage controllers maintain the same AC frequency, amplitude and phase.

> System requirements:

- It must be the same HPS model.
- The program has to be customized parallel program, default single model running programs is not applicable in parallel case.
- At present, it supports at most two HPS in parallel.

> System wiring diagram shown as follow;

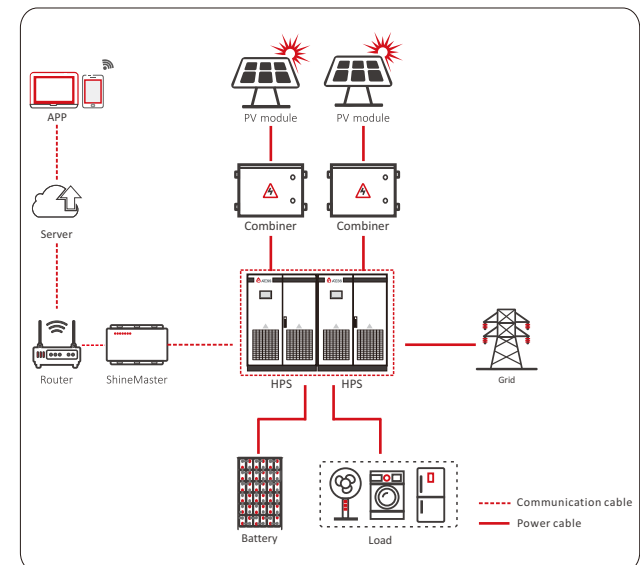

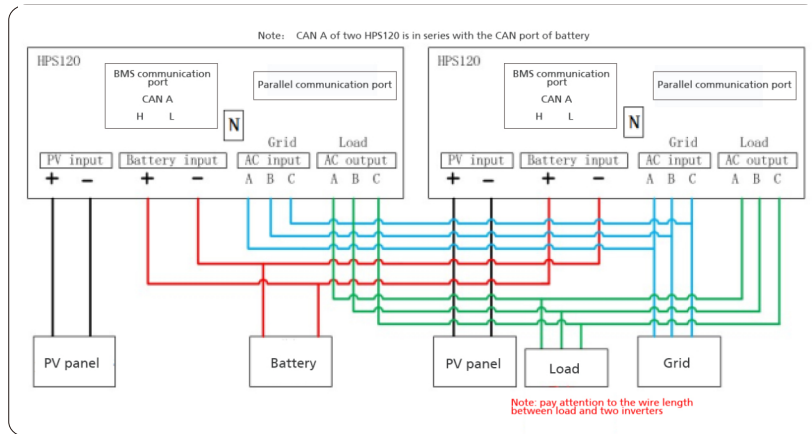

➤ Wiring instructions:

1. Pay attention to the same photovoltaic configuration of each equipment.
2. In order to reduce the circulation loss, it is recommended to share the battery. When it is a lithium battery with BMS, both computers need to communicate with BMS.
3. The two HPS supply load together, The load terminals of the two paralleled units are connected before connecting to load, and the length from combination point of the two HPS to the load terminals must be the same.
4. The two HPS share the utility grid or generator. When require to switch between these two power source, it shall be used with ATS. The installation method is the same as that of single unit installation.
5. The parallel system has special parallel communication port and communication line, which connects the two parallel machines.
6. In order to ensure the communication quality, please install the paralleled inverters at the same location to reduce the communication distance. The complimentary line of parallel communication is only 5 meters long, the paralleled inverters distance should be within 3 meters.

➤ Operation mode:

The working mode of the parallel system is the same as that of the stand-alone system, but the working mode of each device should be set to the same.

Redundant function selection Description: Redundancy can only be selected when one equipment fails and other equipment can still drive all loads; otherwise, it will cause overload of equipment.

Parallel redundant function selection: this function can only be selected when one equipment fails and other equipment can still drive all loads; otherwise, it will cause overload for the equipment.

Note: parallel operation is a special function. Standard machines may not be equipped with this function. If you need this function, please contact ATESS in advance.

The installation requirements of the parallel system are high. Please contact the after-sales personnel of ATESS to assist in installation and testing before preparing for installation, so as to ensure the correct operation of the parallel system.

6.1 Inspection before operation

Before the inverter is put into operation, its installation shall be inspected. At least two staff do the inspection according to the items listed below to ensure the correctness of the installation.

Inspection items for installation

- There is no deformation or damage to the inverter.
- Bottom of the inverter is fixed securely, the foundation support is stable and reliable.
- There is enough space around the inverter.
- The temperature, humidity and ventilation conditions of the environment where the inverter is located meet the requirements.
- There is enough cooling air for ventilation.
- Cabinet sealing protection is complete and reliable

Electrical inspection

- Inverter is grounded completely and firmly.
- The grid voltage matches the rated output voltage of the inverter.
- The phase sequence of grid connection is correct, and the tightening torque meets the requirements.
- The positive and negative poles of DC input connection are correct, and the tightening torque meets the requirements.
- Communication wiring shall be correct and keep a certain distance from other cables.
- Cable number is marked correctly and clearly.
- The insulation protection cover is complete and reliable, and the danger warning label is clear and firm.

Other inspection

- All useless conductive parts shall be tied with insulating ties.
- There are no tools, parts, conductive dust or other foreign matters left inside the cabinet.
- There is no condensation of moisture or ice in the cabinet.

6.2 Power on steps

Energy storage controller adopts the integrated AC and DC power supply method, and LCD can be lit when there is AC or DC alone.

> Battery power supply

The battery can be used for the first time power-on. When the battery breaker is closed, the LCD should be on.

> AC power supply

AC power supply can be used for the first time power-on. Turn on AC input switch, bypass switch, AC output switch and the micro breaks, LCD should be on. When the energy storage controller is powered by AC, as long as the battery voltage is detected to be abnormal for more than 10 minutes, all circuit breakers except bypass will be switched off, and inverter won't be able to start and operate when powered by AC source alone. After LCD is lighted by AC power supply, the bypass switch must be off before the machine turns on.

It is recommended to use batteries to light up the screen. After power on, please do not switch the power-on knob immediately. Please check the historical information page and check whether the operation setting is in line with the actual situation. Please refer to Chapter 7 for details.

1. After the LCD is powered on, it enters the startup interface and home page for after 15s, but it still takes about 2 minutes to initialize. the inverter cannot be started until the initialization is completed.

2. at the top right of each page, The communication status between LCD and the inverter's control board (if √, the communication is normal, otherwise ×, communication failure), station number of the communication end where the inverter is located, system time, etc are displayed.

3. After power on and entering the home page, the program needs to be initialized for a period of time. When √ and numbers appear, the initialization is completed.

7.2 LCD operation

7.2.1 Home page

When powered or clicking "Home" button in any interface will enter into the Home page.

The operating status of the inverter output power, safety standard, model, input and output voltage,current information can be viewed in the page. Pressing the following key can switch to other pages.

7 GUI instruction

7.1 LCD display screen introduction

User can view the information of the inverter operation on the LCD touch screen, as well as setting the operating parameters. In order to facilitate the operation, a menu is provided below.

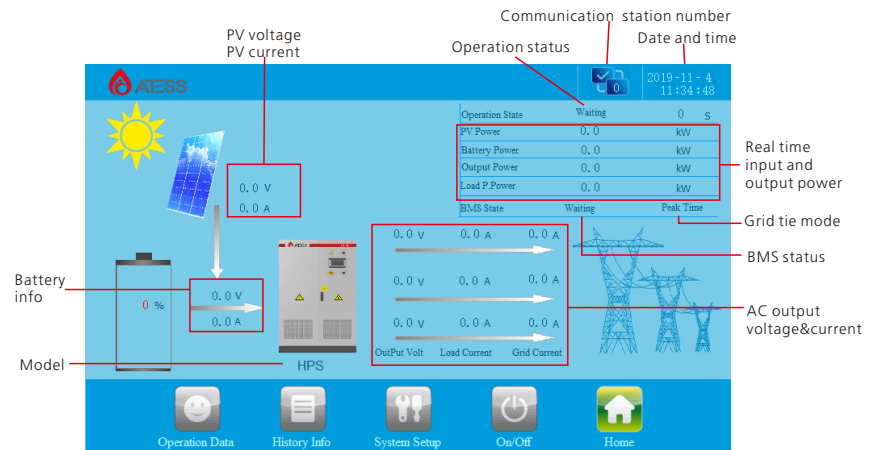
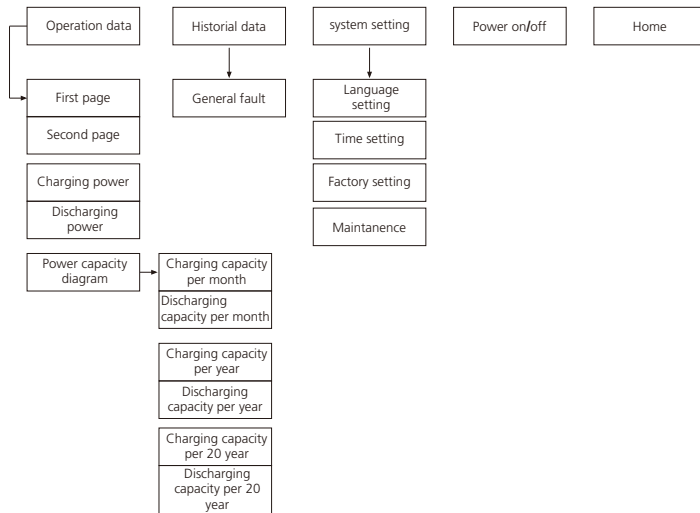

Operation status	Description
Error	Not started or failed to start
Wait	Start initialization
Check	System self checking
Permanent fault	Serious failure occurred
Off grid mode	Off grid mode with load
On grid mode	Successfully connected to grid
PV charge	PV only charging mode
Parallel to off-grid	Parallel system waiting to enter off-grid mode
Parallel to on-grid	Parallel system waiting to enter on-grid mode

Communication station number: the number represents the current station number, which is 485 communication station number. The "√" above the number indicates that the LCD and the control board communicate normally, and when the display is "x", it indicates that the communication is lost.

Grid connected mode: when the operation state of the inverter is grid connected, the current grid connection mode will be displayed: load priority, battery priority, economic mode, peak shifting, EMS mode and diesel generator mode.

BMS status: when it works with lithium battery with BMS, the current BMS status is displayed here. "Wait" is displayed when there is no BMS communication.

7.2.2 ON/OFF interface

Clicking "ON/OFF" button in any interface will enter into this interface.

There are "ON" and "OFF" button which is used to turn on and turn off the inverter.

Start up: turn the start knob to on and click "on" to start up successfully.

Shut down: shut down by clicking "off", or turn the start / stop knob to off directly.

If the machine will be turned off for a long time, use the off-on knob to shut it down.

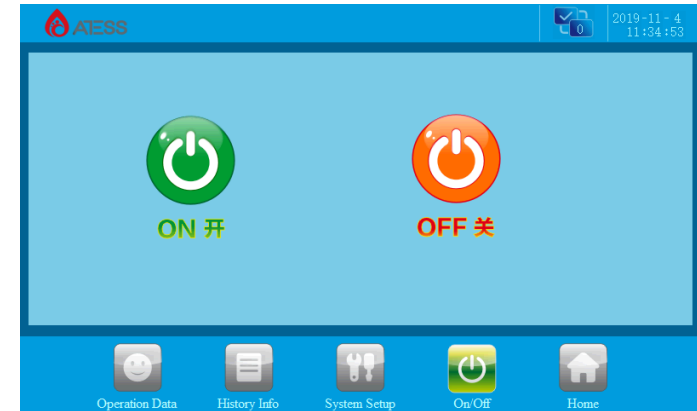

7.2.3 Operation data

Click [operation data] at the bottom of any other interface to enter the submenu of "operation data".

The submenu includes: operation data, power curve, charge and discharge capacity. The corresponding submenu interface can be accessed through the left button. The default one is "operation data" interface.

Operation data: display the current parameters and real-time data of energy storage power generation, including grid voltage, grid frequency, grid current, DC input voltage, DC input current, temperature in the case and total generation time (real-time update).



Charge and discharge capacity: record the charge and discharge capacity of the battery by month, year and 20 year. Click the screen to refresh.

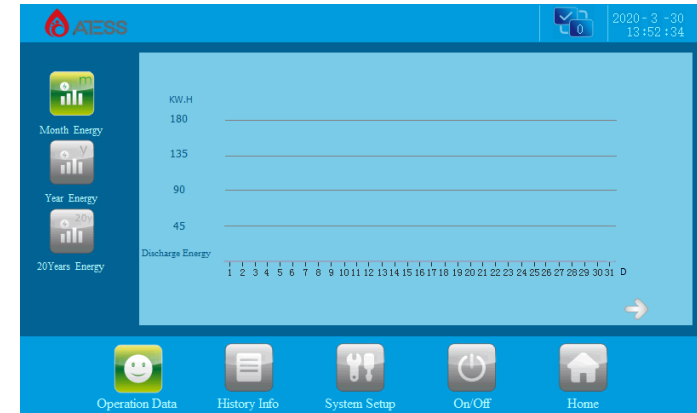

Power curve: display the battery charge and discharge curve of the day, click the screen to refresh.

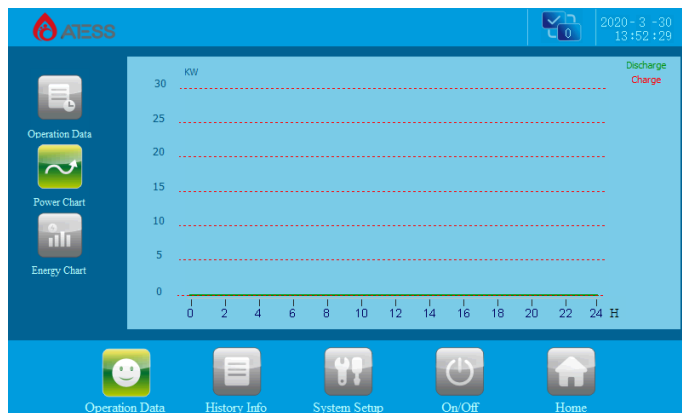

7.2.4 System setting

Clicking "System setting" button in any interface will enter into this interface.

Submenu: language settings, time settings, inverter information, maintenance. Pressing the left button can enter into the corresponding submenu interface. The default one is language setting interface.

Language Settings: Select language, currently it only supports Chinese, English.



Time settings: system time setting (if the date and time displayed on LCD is not inconsistent with the actual date and time, they can be modified here).



Device Information: This page shows the manufacturer, inverter serial number, hardware and software version information, and the date of manufacturing.



Maintenance: the interface requires a password to login. It is for electrician and maintenance personnel who are fully familiar with the structure and working principle of the DC grid system only, in order to avoid damage to personal safety and the inverter.

- Enter the correct password to enter the submenu of "equipment maintenance". The submenu includes: protection parameters, calibration parameters, power grid management, factory settings. The default one is "protection parameters".
- Parameter modification method: modify the set value. Click Save to change the current value to the same value as the set value. There are several reasons why the current value cannot be changed to the set value:
 - LCD response is slow, you can switch pages to speed up the update.
 - The value exceeds the limit and cannot be saved.
 - Other data on this page has errors and cannot be saved.

1. Protection parameters:



Grid Max voltage: If it exceeds Max. power grid voltage, it will switch to off grid mode. The default setting is 110% of rated voltage.

Grid Min voltage: If it gets lower than Min. power grid voltage, it will switch to off grid mode. The default setting is 90% of rated voltage.

Grid Max frequency: If it exceeds Max. power grid frequency, it will switch to off grid mode. The default setting is rated + 2.

Grid Min frequency: If it gets lower than Min. power grid frequency, it will switch to off grid mode. The default setting is rated-2.

Check time: startup detection time, default 60 seconds, minimum 10 seconds, maximum 300 seconds.

Output power limit: AC output power percentage. It can be set to 1% - 120%, the default setting is 100%, and it is recommended not to exceed 110%.

Output voltage setting: the off-grid output voltage can be set to 380 or 400, and can be changed according to the actual needs. After the change, power off and restart to take effect.

Output frequency setting: the AC output frequency can be set to 50 or 60, and can be changed according to the actual needs. After the change, power off and restart to take effect.

Charge_curr: you can modify the battery charging current by changing this value. Please set it according to the actual parameters of the battery to avoid losses caused by battery overcharge. When the battery is with BMS, the BMS will send the maximum charging current limit, compare it with the charging current set on the screen, and take the smaller value for charging.

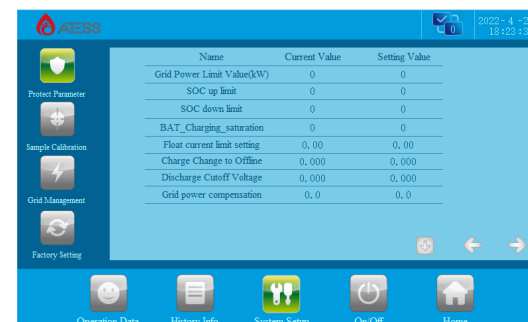

Grid power limit value: the maximum power can be taken from the grid.

SOC up limit/SOC down limit: only valid in diesel generator mode and when the battery has BMS. When off grid and the current SOC is lower than the Min. SOC, the inverter sends the diesel generator starting command; in diesel generator mode, the current SOC is higher than the upper SOC limit, and the inverter sends the diesel generator closing command.

BAT_Charging_saturation: it only takes effect in on-grid mode. When the battery voltage stops discharging due to undervoltage or discharge cut-off and turns to charging, the discharge can be resumed only when the battery unit voltage reaches the set value.

$$\text{Recovery discharge unit voltage} = \text{floating charge unit voltage} - \frac{\text{battery saturation set value}}{10}$$

Float current limit setting: set current limiting charging, when the current unit voltage is greater than (floating cell voltage - floating charge current limiting point), enter the current limiting charging state.

$$\text{Target charging current} = \frac{\text{floating cell voltage} - \text{current unit voltage}}{\text{floating charge current limiting point value}} * \text{battery charging current set value}$$

When the battery is with BMS, the charging current setting value of the battery will be compared according to the maximum charging current limit value sent by the BMS and the charging current setting value set on the screen, whichever is smaller.

The real-time cell voltage of the battery will be calculated according to the maximum cell voltage sent by the BMS.

When there is no BMS, it will enter floating charge current limiting mode in the DG mode and send the instruction to shut down the DG.

Charge change to offline: in PV charge charge, when the cell voltage reaches the set value, it will automatically switch to off-grid mode;

Discharge cutoff voltage: When the unit battery voltage reaches the discharge cut-off voltage, the battery stops discharging(in off-grid mode start te generator or keep discharging till undervoltage and turns into PV charge charge).

Grid power compensation: forcibly reduce the power taken from grid to maximum of 10kW.

➤ This page is the battery parameter setting page. As battery is an important part of the energy storage system, the battery parameters need to be carefully confirmed whether they are consistent with the actual situation.

Batteries: the number of battery in parallel. E.g. 2V / 200ah battery, 240 in series and 2 in parallel, the number of groups should be 2.

Battery cells: the number of batteries in each string. E.g. 2V / 200ah battery, 240 in series and 2 in parallel, the number in each string should be 240.

Battery capacity: single unit battery capacity, unit: ah. If 2V / 200ah, 240 in series and 2 in parallel, the capacity is 200ah.

Max current charge: protection value of total charging current of battery.

Max current discharge: protection value of total discharge current of battery.

Floating charge volt: for setting the floating charge unit voltage of the battery. When the battery cell voltage reaches this setting value, the charging current approaches 0A. Calculate with the maximum cell voltage sent by BMS if there is BMS, otherwise calculate with the average voltage.

UnderVolt_Warning: the unit voltage when the battery undervoltage alarm is generated. The minimum cell voltage sent by BMS is used when BMS is present, otherwise the average voltage is used for calculation.

UnderVolt_Fault: the unit voltage value when the battery undervoltage protection is activated. When the battery voltage reaches this set value, the HPS will protect and stop. The minimum cell voltage sent by BMS is used when BMS is present, otherwise the average voltage is used for calculation.

OverVolt_Fault: the unit voltage value when the battery overvoltage protection is activated. When the battery voltage reaches this set value, the energy storage controller will protect and stop. The maximum cell voltage sent by BMS is used when BMS is available, otherwise, the average voltage is used for calculation.

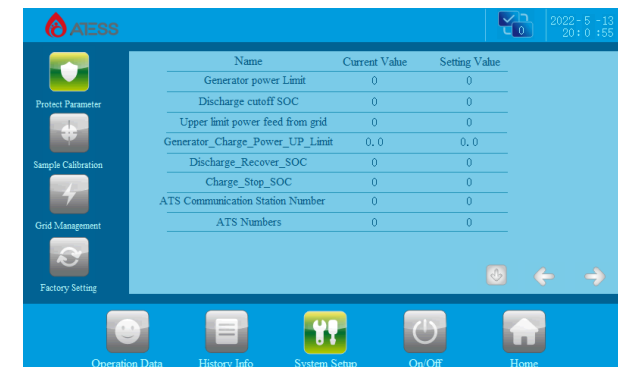
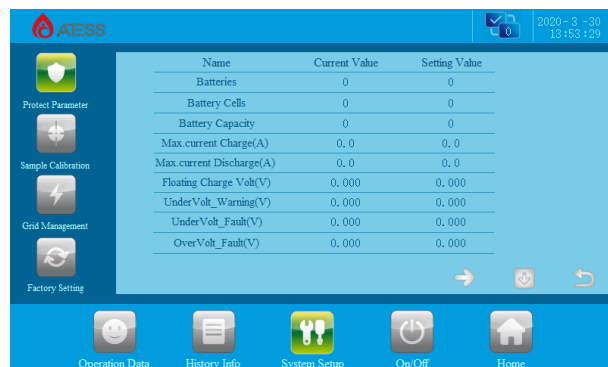

Generator power limit: only takes effect in the DG mode . It is the upper limit of the power taken from DG, and the limit of charging + running load. Note that the upper limit of DG power cannot be lower than the total load value.

Discharge cutoff SOC: when the battery is with BMS and the SOC reaches the set value, the energy storage controller will stop the battery discharge and only the grid connected state will take effect; It does not take effect when the battery has no BMS, and the discharge cut-off voltage is used for judgment when there is no BMS.

Upper limit power feed from grid: the maximum power fed to the grid, including PV, which can limit the grid feeding power.

Generator_Charge_Power_Up_Limit: the maximum charging power of the DG to the battery, which can limit the charging power of the DG to the battery.

Discharge recover SOC: when the battery is a battery with BMS, trigger the discharge cut-off SOC and stop the discharge. When the SOC returns to the set value, the discharge can continue, and only the grid connected state takes effect; When the battery has no BMS, it will not take effect. When there is no BMS, it will be judged by discharge saturation.

Charge_Stop_SOC: when the battery with BMS, the SOC reaches the set value and stops charging. It will not take effect when the battery has no BMS; This setting value and floating charge voltage are effective at the same time, whichever comes first.

ATS communication station No.: no setting is required for single machine system; The parallel system is divided into two cases: 1. Each inverter is equipped with an ATS. In this case, the communication station number should be the same as the 485 address. 2. All inverters share one ATS and do not need to be set.

Number of ATS: the number of ATS in the system.



This page will be set according to the technical agreement before delivery

This page is the economic mode time period setting page, which only takes effect in economic mode. The time period after 24 o'clock must be divided into two settings. For example, 20:00-6:00 is the valley period, which needs to be set as 20:00-24:00, 00:00-6:00.



The page without instructions is factory preset parameter, please do not modify. If the subsequent scheme changes, please modify the parameters under the guidance of ATESS.

2. Calibration parameters:

The modified parameters will be saved automatically. Failure to automatically save after modification means that this function cannot be enabled, if so please contact ATESS.



Island protect level: it is a protection to prevent the inverter from not correctly switching into off grid mode in case of grid abnormality. Enter 0-9,0 means disable; 1-9 means level, suggested not to set too high.

Manual adjustment enable: only used to modify important parameters, do not open it at ordinary times. Please set under the guidance of ATESS.

Bypass_cabinet enable: when inverter is used with ATS produced by ATESS, the bypass cabinet enabling needs to be modified to 1; otherwise, set to 0. When using ATS of other manufacturers, set it to 2, grid and generators will be distinguished through dry contact signal detection (see chapter 5.6 for specific operation methods).

BMS communication enable: when inverter communicates with the battery in BMS, set it to 1; otherwise, set to 0.

Anti-reflux enable: when set to 1, inverter will not feed power to grid; when set to 0, inverter will feed power to grid.

Generator enable: when the input end of the power grid of the inverter is connected to diesel generator, generator enable should be set to 1, otherwise set to 0. When using with ATS to connect generator, it should also be set to 1 as well as the Bypass_cabinet enable.

Grid&PV charge together enable: when set to 1, power grid and PV can charge the battery at the same time; in diesel generator mode, generator and PV can charge the battery at the same time. PV supply as priority, when it is insufficient, it is supplemented by power grid or generator; when it is set to 0, power grid and PV can not charge battery at the same time. In generator mode, the generator and PV can not charge battery at the same time. It is preferentially supplied by PV. Only when PV has no power can the generator or power grid charge the battery.

Parallel enable: when it is set to 1, parallel function is enabled. All the parallel units needs to be set to 1.

Number of parallel machines: number setting of parallel system. When 2 inverters in parallel, set as 2; when three units set as 3.

Parallel address: the address of the parallel system, which cannot be repeated. The address must be set from No. 1 and must be continuous; Address 1 is the host.

Parallel redundant number: Maximum number of faulty machine, can be set to 0 or 1. When set to 0, if one machine in the parallel system goes down, all machines will turn into faulty mode; If set to 1, when the faulty number is less than 1, the other machine keeps running(max. faulty number that can be supported is 1).

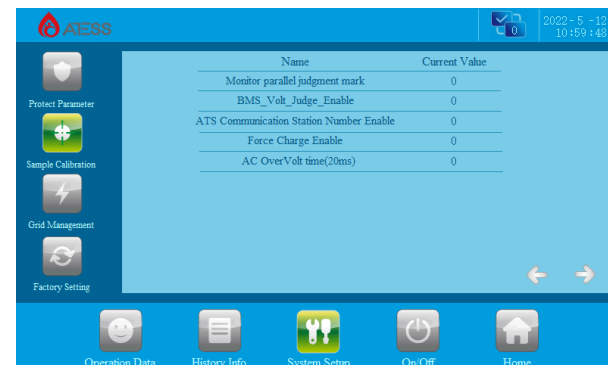

Monitor parallel judgment mark: when the system is a parallel system, the inverter in the same system should be set with the same value. During monitoring, the data of the parallel system will be automatically counted on the monitoring page, otherwise only the data of single inverter will be recorded. Setting to 0 means it is not enabled.

BMS_Volt_Judge_Enable: when the SOC calculation accuracy of BMS is poor, it will affect the system operation, and it is necessary to use the monomer voltage for judgment, set it to 1, otherwise set it to 0.

ATS communication station number enable: it is used when it is necessary to set the ATS communication station number. First set the enable to 1, and then modify the ATS communication station number; After the modification is successful, the enable bit must be set to 0. Only the corresponding energy storage controller and ATS shall be turned on. After setting, turn off the power supply and set other inverters to avoid repeated distribution.

Force charge enable: set to 1 when matching with the battery produced by ATESS, otherwise set to 0.

AC overvolt time (20ms): under off grid mode, when the inverter triggers the delay protection of AC overvoltage, do not modify it, in case affecting the stable operation of the system.

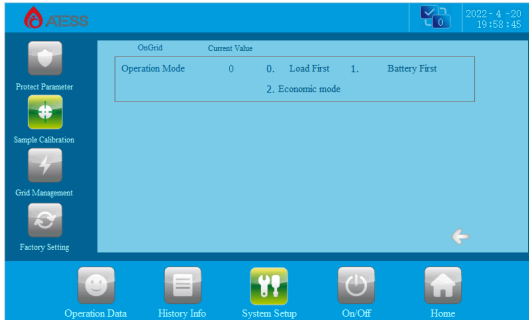

> On-grid mode selection page:

1. Input different numbers and select different grid connection modes.
2. When using ATS, the system selects the corresponding grid connection mode or DG mode according to the actual access.



If user has customized the operation mode, please do not modify it.
 The page without instructions is the factory preset parameter, please do not modify.
 If the subsequent scheme changes, please modify the parameters under the guidance of ATESS.

3. Power grid management

Parameters on this page are very important and are preset by the factory. Please do not modify without permission from ATESS. Otherwise, ATESS will not be responsible for the consequences.



The unspecified pages are factory preset parameters and should not be modified.
 If the solution changes, please modify the parameters under the guidance of ATESS.

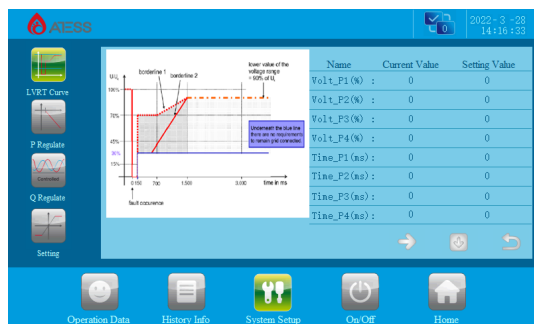

The parameters on this page are important and factory default parameters. Do not modify them.

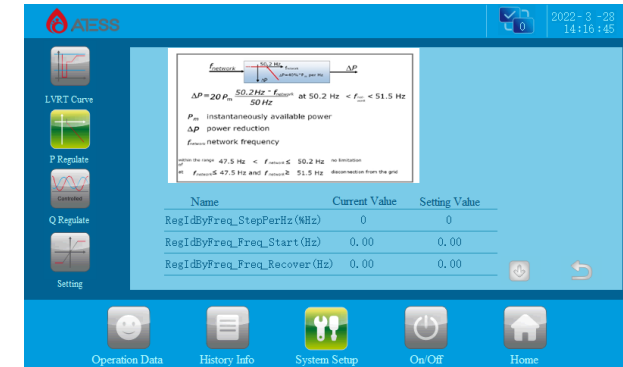

The parameters on this page are important and factory default parameters. Do not modify them.

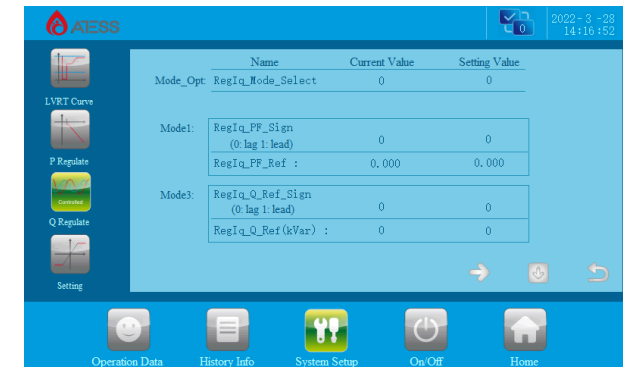

The parameters on this page are important and factory default parameters. Do not modify them.

This page takes effect after reactive power adjustment is enabled.

Mode selection: Select the reactive power adjustment mode and set it to 1 or 3. Only 1 and 3 take effect temporarily.

Mode 1: Adjust the output power factor and direction of the energy storage controller.

Mode 3: Adjust the reactive power value and direction of the energy storage controller.

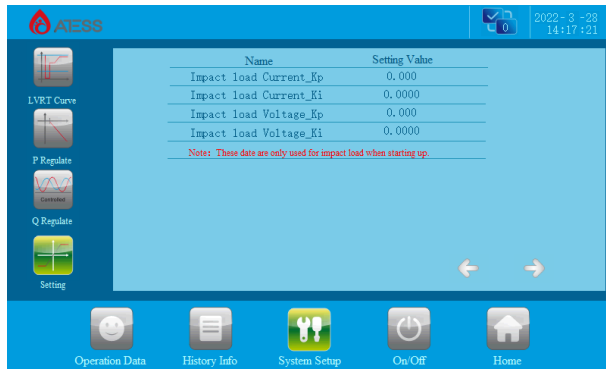

The last two pages of the protection point are important operation PI parameters, which affect the stable operation of the output. Please do not modify the PI parameters by yourself, but only with the permission of ATESS.

i The page without instructions is the factory preset parameter, please do not modify. If the subsequent scheme changes, please modify the parameters under the guidance of ATESS.

4. Factory settings



The value on this page are important factory preset parameters. Please do not modify them without consent of ATESS.

i The page without instructions is the factory preset parameter, please do not modify. If the subsequent scheme changes, please modify the parameters under the guidance of ATESS.

Serial number: equipment serial number, on the nameplate of the inverter.

Safety select: safety Settings, default parameters, can not be modified.

Safety regulation setting: safety regulation selection, default parameter, do not need to modify.

Model select: select the model of inverter according to the actual model, and do not modify it. Due to the slight difference in the design of different models, the wrong model will lead to the failure to start and clear the parameter settings, resulting in unnecessary losses. If it needs to be modified for special reasons, please modify it under the guidance of ATESS after-sales team. After modifying the model, restart it to take effect.

Station: RS485 communication address setting. If it is a parallel system, be sure to set it from 1.

Production date: Set the factory production date.

Save: Click Save after modifying the data.

Restore factory settings: clear all power records, but do not clear parameter settings.

7. 2. 5 Historical information

Clicking "historical information" can enter into the sub-menu of the "historical information".

The submenu includes: Common historical failure, serious historical failure. Via the left button you can enter the corresponding submenu interface. The "common historical faults" is the default interface.

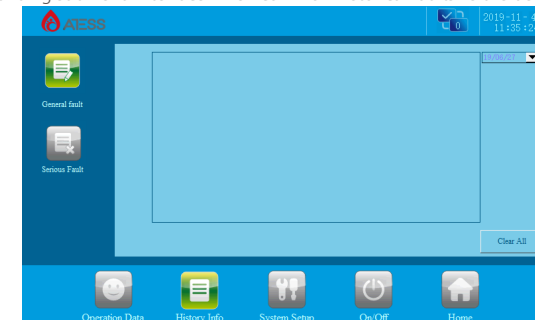

History of failure: all the common history of failure details can be found by flipping the page up and down.

The common fault information, see table 7.3.

7.2 LCD display information schedule

General history failure table

NO	Information	
	English	Chinese
1	PV_Inverse_Failure	PV接反永久故障
2	IGBT_Failure	IGBT永久故障
3	EEPROM_Write_Failure	EEPROM写永久故障
4	EEPROM_Read_Failure	EEPROM读永久故障
5	AC_MainContactor_Failure	主接触器永久故障
6	AC_SlaveContactor_Failure	辅接触器永久故障
7	GFDI_Failure	GFDI永久故障
8	GFCI_Failure	GFCI永久故障
9	RISO_Failure	绝缘阻抗永久故障
10	PV_VoltHigh_Fault	PV电压高故障
11	Bypass_Communication_Fault	旁路柜通信故障
12	PV_CurrHigh_Fault	PV电流过流故障
13	BMS_Communication_Fault	BMS通信故障
14	PV_Insulation_Fault	PV对地绝缘阻抗故障
15	BMS_Fault	BMS故障
16	DC_OCP_Fault	直流过流故障 (Trip)
17	Smoke_alarm_Fault	烟雾报警故障
18	INT_PV_OverVolt_Fault	PV过压故障 (INT)
19	INT_PV_OverCurr_Fault	PV过流故障 (INT)
20	IGBT_Converter_Fault	控制器IGBT故障
21	IGBT_Buck_Fault	Buck IGBT故障
22	Converter_L_OCP_Fault	控制器电感过流故障 (Trip)
23	Buck_L_OCP_Fault	Buck电感过流故障 (Trip)
24	AC_NoUtility_Fault	交流无市电故障
25	AC_GridPhaseSeque_Fault	交流电网相序反故障
26	AC_PLL_Fault	交流锁相故障
27	AC_Volt_Unbalance_Fault	交流电压不平衡故障
28	AC_Curr_Unbalance_Fault	交流电流不平衡故障
29	AC_WU_OverVolt_Fault	交流WU过压故障

NO	Information	
	English	Chinese
30	AC_WU_UnderVolt_Fault	交流WU欠压故障
31	AC_VW_OverVolt_Fault	交流VW过压故障
32	AC_VW_UnderVolt_Fault	交流VW欠压故障
33	AC_UV_OverVolt_Fault	交流UV过压故障
34	AC_UV_UnderVolt_Fault	交流UV欠压故障
35	AC_OverFreq_Fault	交流过频故障
36	AC_UnderFreq_Fault	交流欠频故障
37	AC_GridCurr_DcHigh_Fault	电网直流量高故障
38	GridCurr_High_Fault	电网电流高故障
39	Buck_Module_OverTemp_Fault	Buck模块过温故障
40	Converter_L_OverTemp_Fault	变流器电感过温故障
41	Buck_L_OverTemp_Fault	Buck电感过温故障
42	Transformer_OverTemp_Fault	变压器过温故障
43	LowTemp_Fault	低温故障
44	EPO_Stop	紧急停机
45	KeyEmergencyStop	手动关机
46	LcdEmergencyStop	LCD关机
47	DC_MainContactor_Fault	直流主接触器故障
48	PV_Thunder_Fault	PV直流防雷器故障
49	AC_Thunder_Fault	交流防雷器故障
50	DC_SoftStart_Fault	DC软启故障
51	INT_ConverterL_OverCurr_Fault	变流器电感过流故障 (INT)
52	INT_BuckL_OverCurr_Fault	Buck电感过流故障 (INT)
53	Batt_OverVolt_Fault	电池过压故障
54	Batt_UnderVolt_Fault	电池欠压故障
55	Batt_OverCurr_Fault	电池过流故障
56	Batt_OverCharge_Fault	电池过充故障
57	Fault_Feedback_Warning	故障反馈告警
58	Batt_UnderVolt_Warning	电池欠压告警
59	AC_WU_OverVolt_Rmt_Warning	交流旁路WU过压
60	AC_WU_UnderVolt_Rmt_Warning	交流旁路WU欠压
61	AC_VW_OverVolt_Rmt_Warning	交流旁路VW过压
62	AC_VW_UnderVolt_Rmt_Warning	交流旁路VW欠压
63	AC_UV_OverVolt_Rmt_Warning	交流旁路UV过压
64	AC_UV_UnderVolt_Rmt_Warning	交流旁路UV欠压

8 Operation

8.1 Power on steps

After installation and system settings are inspected, inverter can be started for operation.

> First run

The first operation steps are as follows:

1. Turn on the PV, battery, AC input and power supply micro breaks, and do not turn on the AC output switch before the system operates normally to avoid any impact on the load;
2. Bypass switch shall be closed when it is in normal operation;
3. Check whether the screen sampling data is abnormal and consistent with the actual situation;
4. Check whether the battery parameter setting is consistent with the actual battery, if not please modify.
5. If the battery has BMS, check whether the BMS is enabled and normal.
6. If the grid input end is connected to generator, check whether generator is enabled.
7. If it is equipped with ATS manufactured by ATESS, check whether the bypass cabinet is enabled.
8. Check the history information page of the screen, and check whether there are serious faults according to the general faults in Chapter 8.3.
9. After checking, turn the knob to "on", click "on" on the LCD "on / off" page, and wait for the machine to enter "grid connection"; if the site is off grid, it will enter "off grid mode" after starting;
10. During operation, observe whether the data displayed on the screen is normal and whether there is fault information reported, and whether the machine has abnormal noise and smell; if any abnormal situation occurs, please stop the machine immediately for inspection.



Warning!

The bypass switch is only used for maintenance. Please do not turn it on during normal operation.

Manual shutdown

1. After clicking the LCD shutdown button to shut down the machine manually, it must be turned on manually through the start button (on) on the LCD; if the machine is turned off by turning the knob to "off", turn the HPS knob to "on" first, and then click the "on" button on the LCD "switch on" page to start the machine, otherwise inverter cannot start automatically.
2. The inverter is still electrified after manual shutdown.

8.2 Pilot operation completion

The following procedures shall be carried out after the inverter is normally in operation.

Procedure 1: Inspect whether abnormality exists in the inverter, such as excessive noise, excessive heat, abnormal smell or smoke.

Procedure 2: Measure whether inverter voltage, current and THD are stable.

Procedure 3: Operate LCD control panel and inspect whether it displays normally and accurately.

Procedure 4: Test whether it conforms to the preset operation logic.

By now, the pilot operation of inverter is fully completed, and we can enter the daily operational maintenance.

8.3 General troubleshooting

If there is a fault during the operation, please click the LCD "history information" page to view the fault information. The following are the common fault analysis and handling steps of HPS:

1. Key emergency stop: turn HPS panel knob to "off"

Handling steps: the knob is shut down normally, no need to handle.

2. LCD emergency stop: click "off" on HPS screen

Processing steps: the screen is shut down normally, no need to handle.

3. Emergency stop: emergency stop button pressed.

Handling steps: release the emergency stop button in case of no other abnormalities.

4. Batt_UnderVolt_Fault:

Possible reasons:

- a. The battery voltage sampled on the screen reaches the under-voltage protection condition and triggers it.
- b. The switch of battery on battery side or the on the energy storage controller is not turned on.
- c. If this fault occurs during operation, the battery voltage may be pulled down due to high-power output, or the battery itself may be defective.
- d. If it is a battery with BMS, this fault will also occur if the lowest cell voltage of the battery unit transmitted by the BMS to the energy storage controller reaches the protection condition.

Processing steps:

- a. First, check the battery connection, screen sampling error, and battery parameter settings.
- b. If it is a battery with BMS, check whether the BMS data meets the protection conditions.
- c. If there is no problem with the above, please contact ATESS for assistance.

5. Batt_OverVolt_Fault:

Possible reasons:

- a. The battery voltage sampled on the screen reaches the overvoltage protection trigger condition.
- b. If it is a battery with BMS, this fault will also occur if the highest cell voltage of the battery unit transmitted by the BMS to the energy storage controller reaches the trigger protection condition.

Processing steps:

a. Check whether the number of battery cells and the overvoltage protection value are set correctly. If not, please set the parameters correctly.

If the parameters are correct due to the overvoltage of the battery itself, please contact ATESS for assistance.

6. **Batt_OverCharge_Fault:** the battery charging current is higher than the maximum charging current.

Processing steps: check whether the battery charging current setting value and the maximum charging current value are reasonable. The maximum charging current value of the battery shall be set according to the recommendations given by the battery manufacturer. The setting value of the battery charging current shall be less than the maximum charging current protection value.

7. **Batt_OverCurr_Fault:** the battery discharge current is higher than the maximum discharge current

Processing steps: check whether the maximum discharge current value of the battery is reasonable, multiply the maximum discharge current by the battery voltage, calculate the maximum discharge power of the battery, see whether it is less than the load power, if yes, reduce the load power.

8. **BMS_Fault:** secondary or tertiary battery failure

Processing steps:

- A. check the specific faults reported by BMS
- B. contact the battery manufacturer to solve the problem
- C. restart after troubleshooting

9. **BMS_Communication_Fault:** the energy storage inverter did not receive CAN data sent by battery BMS

Processing steps:

- A. check whether the CAN line of ATS is connected to the CAN-A port of the inverter's control board.
- B. check if the L and H CAN line are connected reversely.
- C. check whether the CAN line is interfered. Suggest to use sampling shielded communication line.
- D. use the CAN box to check whether there is data sent by the BMS on the bus.
- E. if the communication still fails, contact ATESS.

10. **Bypass_Communication_Fault:** the energy storage inverter did not receive can data sent by bypass cabinet

Processing steps:

- A. check whether the CAN line of ATS is connected to the CAN-B port of the inverter's control board.
- B. check whether the L and H CAN line is connected reversely
- C. check whether the CAN line is interfered. Suggest to use sampling shielded communication line.
- D. use CAN box to check if there is data sent by ATS on the bus.
- E. if communication still fails, contact ATESS.

11. **AC_NoUtility_Fault: no AC voltage.**

Processing steps: generally, this fault will not fade out because there is no output due to other reasons.

12. **AC_OverFreq_Fault:** the power grid frequency exceeds the upper limit, and the energy storage inverter enters off grid state.

Processing steps: check whether the upper limit of power grid frequency is reasonable. If yes, wait until it returns to normal, the inverter will automatically enter into grid connection state.

13. **AC_UnderFreq_Fault:** the power grid frequency is lower than the lower limit, and the energy storage inverter enters the off grid state.

Processing steps: check whether the lower limit of power grid frequency is reasonable. If yes, wait until the power grid frequency returns to normal, HPS will automatically enter into grid connection state.

14. **AC_UV_OverVolt_Rmt_Warning:** when the utility grid voltage is higher than the upper limit, the energy storage inverter enters off grid state.

Processing steps: check whether the upper limit setting of power grid voltage is reasonable. If yes, wait until the power grid voltage returns to normal, and HPS will automatically enter into grid connection state.

15. **AC_VW_OverVolt_Rmt_Warning:** when the grid voltage is higher than the upper limit, HPS enters off grid state.

Processing steps: check whether the upper limit setting of power grid voltage is reasonable. If yes, wait until the power grid voltage returns to normal, and HPS will automatically enter into grid connection state.

16. **AC_WU_OverVolt_Rmt_Warnin:** when the grid voltage is higher than the upper limit, HPS enters off grid state.

Processing steps: check whether the upper limit setting of power grid voltage is reasonable. If yes, wait until the power grid voltage returns to normal, and HPS will automatically enter into grid connection state.

17. **AC_UV_UnderVolt_Rmt_Warning:** when the grid voltage is lower than the lower limit, HPS enters off grid state.

Processing steps: check whether the lower limit setting of power grid voltage is reasonable. If yes, wait for the power grid voltage to return to normal, and HPS will automatically enter into grid connection state.

Routine maintenance 9

18. **AC_VW_UnderVolt_Rmt_Warning**: when the grid voltage is lower than the upper limit voltage, HPS enters off grid mode.

Processing steps: check whether the lower limit setting of power grid voltage is reasonable. If yes, wait for the power grid voltage to return to normal, and HPS will automatically enter into grid connection state.

19. **AC_WU_UnderVolt_Rmt_Warning**: when the grid voltage is lower than the upper limit voltage, HPS enters off grid state.

Processing steps: check whether the lower limit setting of power grid voltage is reasonable. If yes, wait for the power grid voltage to return to normal, and HPS will automatically enter into grid connection state.

20. **AC_GridPhaseSeque_Fault**: reverse phase sequence connection of power grid

Processing steps: check the three lines of phase sequence U V W of the utility grid, which are corresponding to A B C connected to the AC input terminal of inverter.

21. **OverTemp_Fault**: the temperature inside of the machine is too high.

Processing steps:

A. check whether the power supply micro break of the inverter is turned on. If not, turn it on.

B. check whether HPS air inlet and outlet are blocked, and clean dust regularly.

C. wait for the machine to cool down, the fault is eliminated and inverter restart normally, and observe whether the fan works when the temperature reaches 60 °C. If not, please contact ATESS.

Regarding other faults, please contact relevant professionals of ATESS.

8.4 Power off steps



CAUTION!

After the inverter is completely powered off, the general DC switch at battery side and the Grid switch at grid side still maintain voltage. If operations are needed, please be sure to cut off the outer power completely, and wait for not less than 5 minutes.

1. Click the OFF button on LCD or turn the off-on knob from ON to OFF;
2. Cut off DC SWITCH PV input and Battery input;
3. Cut off AC SWITCH AC input and AC output;



CAUTION!

It is normal for the inverter to give alarm during power off. The power down steps can be continued.

9.1 Regular maintenance







Due to the influence of environment temperature, humidity, dust and vibration, the devices inside the inverter will be aged and worn, which will lead to potential failure inside the machine. Therefore, it is necessary to carry out daily and regular maintenance to ensure its normal operation and service life. All measures and methods to help the inverter in good working condition belong to the scope of maintenance work.

9.1.1 Safety precautions

- (1) Only qualified and authorized personnel can maintain the inverter.
- (2) When carrying out maintenance work, do not leave the screws, washers and other metal parts in the inverter, otherwise the equipment may be damaged.
- (3) If only the circuit breaker is opened, the cable connection terminal inside the inverter is still electrified.
- (4) Before opening the cabinet door and starting the formal maintenance work, it is necessary to not only disconnect the circuit breaker, but also disconnect the front and rear level circuit breakers of the inverter.
- (5) After the inverter stops operation, please wait at least 5 minutes before operating.
- (6) Disconnect all external connections of the inverter and the internal power supply of the equipment.
- (7) Ensure that the inverter is not inadvertently recharged.
- (8) Use a multimeter to ensure that the inverter is completely electrically neutral inside.
- (9) Make necessary grounding and short circuit connections.
- (10) Use insulating material cloth to cover the parts near the operation part that may be electrified.

9.1.2 System maintenance

Tools to be used during maintenance

	Cell phone that can take photos
	Multimeter
	Thermometer
	Pen and paper
	Spanner, screwdriver etc
	Thermal imager

2.1 Maintenance and inspection checklist for running system

When recording inspection and maintenance, inspection shall be carried out one by one following the table sequence, and the faulty items shall be described accordingly.

Please refer to Capture 10.3 Maintenance and inspection checklist for non-shutdown system.

After the inspection record is completed, photos of the operation status in home page and historical information page shall be taken for record, as shown in the following figures:



2.2 Maintenance and inspection checklist for shutdown system

Please refer to Capture 10.4 Maintenance and inspection checklist for shutdown system.

9.1.3 Relative operations



CAUTION!

All maintenance operations must be carried out in the condition that DC side and AC side of the inverter, PV module and AC distribution cabinet switch are all disconnected. Maintenance must be proceeded only after AC and DC disconnected for at least 5 minutes, in order to avoid electric shock!

Only professional technicians familiar with the system operation can perform such operation.

Disconnect the circuit breaker

Operate the DC switch of PV input and battery input to disconnect HPS from the PV and battery. And operate AC input and AC output switches to disconnect HPS from AC sources. Make sure that HPS won't switch on accidentally. Test with a multimeter to make sure the device is disconnected and with zero voltage. Even if HPS has been disconnected from the grid / main power supply, battery and PV, some of the internal components (such as capacitors) still have residual voltage and discharge slowly, so please wait at least 5 minutes after the circuit breaker is disconnected and use the multimeter to measure and confirm the safety before continuing operation.

How to use bypass switch

If the HPS fails and cannot continue to operate, it needs to be shut down for maintenance, while the load connected to the HPS needs to continue working, the bypass switch can be used to keep the load work uninterruptedly under the power supply of power grid or generator, and the maintenance personnel can carry out maintenance work safely.

Step 1: turn on the bypass switch in case of machine failure.

Step 2: turn off the switches of "AC input", "AC output", "PV input" and "battery input". At this time, the AC and DC power are disconnected from HPS, and the load is all supplied by the power grid, after the residual power is discharged, maintenance work can be carried out.

Note:

1. After power off, wait for 5 minutes to confirm safety before carrying out maintenance work.
2. Use the multimeter to ensure safety before disassembling and other work.

Function and safety parameters

Do not change parameters of HPS without the authorization of the local power supply company and the instruction of ATESS. Unauthorized change of functional safety parameters may cause injury to personnel or inverter damage, in this case, ATESS will not provide warranty services.

Replace the dust screen

During the use of HPS, the dust on the top shall be cleaned regularly, and the dust screen at the air inlet shall be cleaned or replaced. During the cleaning, HPS needs to be power-off.

Replacement method of dust screen: the dust filter cotton on the door panel can be directly pulled up for cleaning and replacement.

9.2 Waste disposal

The inverter will not cause environmental pollution, since the all the components meet the requirements of environmental protection. According to environmental protection requirements, user shall dispose the inverter in accordance with the relevant laws and regulations.

10 Appendix

10.1 Specification

Model	HPS50	HPS100	HPS120	HPS150
PV parameter				
PV rated power	55KW	110KW	132KW	165KW
Max. PV power	75KW	150KW	180KW	225KW
Max. PV open circuit voltage	1000V	1000V	1000V	1000V
PV MPPT voltage range	480Vdc-800Vdc			
Max.PV input current	136A	230A	327A	409A
Battery parameter				
Battery operating voltage range	352V-600V			
Max battery charge current	150A	300A	350A	450A
Max battery discharge current	156A	313A	374A	467A
Max battery charge power	75KW	150KW	180KW	225KW
Max battery discharge power	55kw	110kw	132kw	165kw
AC output parameter				
Rated voltage	400Vac			
Rated current	72A	144A	173A	217A
Rated power	50KW	100KW	120KW	150KW
Rated frequency	50/60Hz			
Frequency Range	45-55Hz/55-65Hz			
Max. AC output power	55KVA	110KVA	132KVA	165KVA
Max. AC input power	100KVA	200KVA	240KVA	240KVA
Power factor	0.8lagging—0.8leading			
THDI	<3%(Full load)			
THDU	≤2%			
Overload capacity	110%-10 mins,120%-1 min			
Other parameter				
Ingress Protection	IP20(Outdoors)			
Protective class	Class I			
Mains over voltage category	OVC III			
PV over voltage category	OVC II			
Demand response mode	DRM0-8 (optional)			
Inverter topology	Isolated			
Noise emission	<65dB A @1m			
Cooling	Intelligent air cooling			
Humidity	0%-95% non-condensing			
Maximum altitude	6000 (derate over 3000m)			
Build-in transformer	yes			
Operating temperature	-25 --+55			
Active anti-islanding method	Shifting the frequency of the inverter away from nominal conditions in the absence of a reference frequency (frequency shift)			
Communication				
LCD display	Touch screen LCD			
Communication interface	RS485/CAN			

1.5 times rated PV output: HPS supports 1.5 times rated PV output at most, but the following two conditions(Battery voltage, PV MPPT voltage) need to be met.

Model	Battery voltage (current actual voltage)	PV MPPT voltage	Inrush current	Max.output overcurrent	Feedback current
HPS50	Above 500V	Exceed the max. battery voltage and above 550V	79.3A	86.6A	0A
HPS100	Above 500V	Exceed the max. battery voltage and above 650V	158.7A	173.2A	0A
HPS120	Above 520V	Exceed the max. battery voltage and above 550V	190.5A	207.8A	0A
HPS150	Above 500V	Exceed the max. battery voltage and above 550V	238.1A	259.8A	0A

There are diodes on the PV side to prevent PV reflux. In case of short circuit, HPS will immediately disconnect all contactors and circuit breakers to prevent other equipment from being affected.

Isolation transformer functions and specifications

1. Buck-boost function: Meet the minimum battery voltage of 352V.
2. Electrical isolation: isolate the primary and secondary to ensure safety.
3. Star-delta transformation: forming the N line.

Model	HPS50	HPS100	HPS120	HPS150
Rated capacity	50KVA	100KVA	120KVA	150KVA
Rated frequency	50/60Hz			
Primary rated voltage	200V			
Secondary rated voltage	400V			
Primary rated current	144.3A	288.7A	346A	433A
Secondary rated current	72.2A	144.3A	173A	216.5A
Connection group	Dyn11			
No-load loss	400W	485W	565W	700W
Load loss(75)	1500W	1700W	1900W	2400W
Temperature rise	≤75K			≤90K
Cooling	AF			
Insulation grade	H			
Ingress protection	IP00			
Grounding mode	Neutral ungrounding			
Dielectric strength	3000V,60S,≤15mA			3000V,60S,≤20mA

10.2 Ates Factory warranty

➤ Warranty period

The warranty period of this product is one year. If otherwise specified in the contract, the contract shall prevail.

During the warranty period, the customer shall show the invoice and date of purchase to the service personnel of ATESS. At the same time, the nameplate mark on the product shall be clear and visible, otherwise, ATESS has the right not to provide warranty service.

➤ Warranty conditions

In the event of failure during the warranty period, ATESS will repair or replace the product free of charge; The customer shall Set aside some time to repair the faulty machine.

➤ Liability exemption

In case of the following circumstances, ATESS has the right not to conduct warranty:

1. Products without logo of ATESS Power Technology logo;
2. The product or component that has exceeded the valid warranty period of ATESS;
3. Failure or damage (such as high temperature, low temperature, too wet or dry, high altitude, unstable voltage or current, etc.) caused by working in beyond-specified environment or wrong installation, storage or use that violates the instructions;
4. Failure or damage caused by unauthorized installation, repair, modification or disassembly, except for those authorized by ATESS;
5. Failure or damage caused by using components that not supplied by ATESS;
6. Failure, damage or transportation damage caused by accident or human factors (operation error, scratching, carrying, bumping, improper voltage connection etc.);
7. Failure or damage caused by force majeure (such as earthquake, lightning, fire etc.);
8. Failures or damages caused by other factors rather than quality problems of the supplied product itself(including components).

10.3 Maintenance and inspection checklist for running system

No.	Category	Check item	Method/Tool	Standard	Result	Problem description	Check frequency
1	System operation status check	Whether the LCD display of the machine is in normal operation	Visual inspection screen	Operation status display is not "fault" or "serious fault"	<input type="checkbox"/> Normal <input type="checkbox"/> Abnormal		Once a month
2		Whether there is error recorded in history that caused shutdown	Visual inspection screen	No error caused shutdown	<input type="checkbox"/> Normal <input type="checkbox"/> Abnormal		
3		Whether the data transmission of monitoring device is normal	Monitoring web page / APP	Monitoring connection and data transmission are normal	<input type="checkbox"/> Normal <input type="checkbox"/> Abnormal		
4		Whether the fan rotates normally and the air outlet is normal (first check whether the temperature collected by the equipment reaches the fan opening condition, which normally is 60 °C)	Visual inspection Thermal imager	Normal rotation, normal air output	<input type="checkbox"/> Normal <input type="checkbox"/> Abnormal		
5		Whether the equipment has abnormal smell or sound	Smell, listen	No abnormal sound or smell	<input type="checkbox"/> Normal <input type="checkbox"/> Abnormal		
6		Emergency stop button (when the system is in standby mode)	Manual	The circuit breaker trips after pressing the emergency stop button	<input type="checkbox"/> Normal <input type="checkbox"/> Abnormal		

10.4 Maintenance and inspection checklist for shutdown system

No.	Category	Check item	Method/Tool	Standard	Result	Problem description	Check frequency	
1	System cleaning	Whether there is water leakage or other foreign matters in the room or container	Visual inspection	No water leakage or foreign matter	<input type="checkbox"/> Normal <input type="checkbox"/> Abnormal		Once a month	
2		Whether there are rodents and insects such as rats, geckos, cockroaches and ants in the cabinet	Visual inspection	No animals or insects	<input type="checkbox"/> Normal <input type="checkbox"/> Abnormal			
3		Whether the power cable connection is loose	Manual /Wrench	No looseness	<input type="checkbox"/> Normal <input type="checkbox"/> Abnormal			
4	System cable connection (power-off inspection)	Whether the communication cable connection is loose	Manual bolt driver	No looseness	<input type="checkbox"/> Normal <input type="checkbox"/> Abnormal		Once a month	
5		Check equipment ground connection	Visual inspection /Multimeter	<=4Ω	<input type="checkbox"/> Normal <input type="checkbox"/> Abnormal			
6	Internal cleaning	whether the external connection of the equipment is damaged	Visual inspection	No damage	<input type="checkbox"/> Normal <input type="checkbox"/> Abnormal		Once a month	
7		whether there is moisture or condensation inside the cabinet	Visual inspection	No condensation, no moisture	<input type="checkbox"/> Normal <input type="checkbox"/> Abnormal			
8		Whether there is obvious dust inside the cabinet	Visual inspection	No obvious dust	<input type="checkbox"/> Normal <input type="checkbox"/> Abnormal			
9		Whether the front and rear dust screens has blockage	Visual inspection	No blockage	<input type="checkbox"/> Normal <input type="checkbox"/> Abnormal			
10		Whether there is obvious damage inside the equipment	Visual inspection	No damage	<input type="checkbox"/> Normal <input type="checkbox"/> Abnormal			
11		whether there is obvious rust inside the cabinet	Visual inspection	No rust	<input type="checkbox"/> Normal <input type="checkbox"/> Abnormal			
12		Safety signs		Visual inspection	Safety signs are not shed	<input type="checkbox"/> Normal		
						<input type="checkbox"/> Abnormal		

Note: the table only indicates the recommended maintenance frequency of the product. The actual frequency shall be determined according to the specific installation environment. The scale of power station, location and site environment will affect the maintenance frequency. If the operation environment is windy and dusty, it is necessary to shorten the period and increase the frequency.

10.5 EMS mode RS485 command(EMS mode is DRM mode)

	HPS50	HPS100	HPS120	HPS150
Power on command				
Power off command				
Turn on EMS mode				
Turn off EMS mode				
Rectify AC→DC				
Inverter DC→AC				
0% rated DC/AC power				
25% rated DC/AC power	01 06 00 23 00 0D B9 C5	01 06 00 23 00 19 B9 CA	01 06 00 23 00 1E F8 08	01 06 00 23 00 26 F9 DA
50% rated DC/AC power	01 06 00 23 00 19 B9 CA	01 06 00 23 00 32 F9 D5	01 06 00 23 00 3C 78 11	01 06 00 23 00 4B 38 37
75% rated DC/AC power	01 06 00 23 00 26 F9 DA	01 06 00 23 00 4B 38 37	01 06 00 23 00 5A F8 3B	01 06 00 23 00 71 B8 24
50% rated PV power	01 06 00 21 00 19 18 0A	01 06 00 21 00 32 58 15	01 06 00 21 00 3C D9 D1	01 06 00 21 00 4B 99 F7
100% rated PV power	01 06 00 21 00 32 58 15	01 06 00 21 00 64 D8 2B	01 06 00 21 00 78 D9 E2	01 06 00 21 00 96 59 AE

RS485 instruction formula description
 AB CD EF GH IJ KL MN OP
 AB:485 communication address
 CD:Function code
 EF GH:Register address
 IJ KM:Value
 MN OP: CRC check value of the first 6 bits

The appendix only shows part of the power section instructions. Please write the required instructions according to the 485 instruction formula and control the ATESS Modbus RTU protocol.