



HPS5000TLS
HPS7500TLS
HPS10000TLS

Hybrid energy system User Manual

Shenzhen Ateess Power Technology Co.,Ltd
3rd Floor of Building 9,Henglong Industrial Park, the fourth industrial zone of Shuitian
community, Baoan district, Shenzhen,China

T: +86 755 2998 8492
E: info@ateesspower.com
W: www.ateesspower.com

044.ZT0006300

Contents

1 About this Manual

- 1.1 Contents
- 1.2 Symbols explanation

2 Safety instructions

- 2.1 Correct installation
- 2.2 Operator
- 2.3 Inspection and storage
- 2.4 Transportation
- 2.5 Installation
- 2.6 Repair and maintenance
- 2.7 Inverter EMC and noise level
- 2.8 Important note

3 Product Description

- 3.1 Energy Storage system
- 3.2 Circuit diagram of the inverter
- 3.3 The layout of the main components
- 3.4 Operation mode
- 3.5 Battery setting
- 3.6 Protection
- 3.7 Storage
- 3.8 Dimension
- 3.9 Packaging information

4 Products installation

- 4.1 Installation condition requirements
- 4.2 Tools and spare parts required for whole machine installation
- 4.3 Mechanical installation
- 4.4 Electrical installation
- 4.5 Communication
- 4.6 Installation inspection

5 Pilot operation

- 5.1 Relevant requirements
- 5.2 Inspection
- 5.3 Power on steps
- 5.4 Pilot operation completion
- 5.5 Power off steps

6 GUI instruction

- 6.1 LCD display screen introduction
- 6.2 LCD operation
- 6.3 LCD display information schedule

7 Routine maintenance

- 7.1 Fan maintenance
- 7.2 Regular maintenance
- 7.2 Waste disposal

8 Appendix

- 8.1 Specification
- 8.2 ATESS Factory warranty

1 About this Manual

This chapter describes the contents of this manual, target reader, and safety symbols, can help users to have a better understanding of the manual.

1.1. Contents

This manual applies to ATESS HPS5000TLS/HPS7500TLS/HPS10000TLS hybrid energy system, the manual contains:

Safety instruction

Attention that needs to be paid when operating and maintaining ATESS HPS5000TLS/HPS7500TLS/HPS10000TLS

Product description

The role inverter plays in the energy storage system and structure, principle, protection, operation mode, storage and package size of the ATESS HPS5000TLS/HPS7500TLS/HPS10000TLS.

Installation

Inverter installation conditions, tools, and the inverter mechanical and electrical installation, the communication connection and inspection.

Commissioning

Inspection before commissioning and procedure to turn on/off inverter.

GUI(Graphic User Interface) instruction

Information displayed on the inverter LCD touch-screen and setting instruction. Routine maintenance

Routine maintenance





Daily maintenance of the inverter, the replacement of some spare parts and waste disposal instruction.

Appendix

Technical data, warranty policy and contact information.

1.2. Symbols explanation

In order to ensure the personal and property safety of the user during installation, or optimally efficient use of this product, symbols are used highlight the information. The following symbols may be used in this manual, please read carefully, in order to make better use of this manual.

	DANGER Caution, risk of danger DANGER indicates a hazard with a high level of risk which, if not avoided, will result in death or serious injury.
	CAUTION CAUTION indicates there is potential risk, if not avoided, could result in equipment malfunction and property damage.
	WARNING Caution, risk of electric shock
	PE TERMINAL Protective conductor terminal

2 Safety instructions

Inverter installation and service personnel must be trained and familiar with the general safety requirement when working on electrical equipment. Installation and service personnel should also be familiar with the local laws and regulations and safety requirements.

- > Read this manual carefully before operation. The equipment will not be under warranty if failing to operate according to this manual.
- > Operation on the inverter must be for qualified electrical technician only.
- > When inverter operating, don't touch any electrical parts except for the touchscreen.
- > All electrical operation must comply with local electrical operation standards.
- > Warranty service for the inverter does not contain module maintenance.
- > Permission from the local utility company is required before installing the Energy Storage system and only professional personnel are qualified for the operation.

2.1. Proper installation method

Proper installation requires following all the instructions in the user manual involving transportation, mounting, wiring and commissioning. ATESS does not cover warranty for the inverter damage due to failing to use it properly.

- >Note the instruction in this chapter and after
- >follow the manual
- >consider relevant data and technical spec

2.2. Operator

Inverter installation and service personnel must be trained and familiar with the general safety requirement when working on electrical equipment. Installation and service personnel should also be familiar with the local laws and regulations and safety requirements.

2.3. Inspection and storage

The inverter should be carefully checked before signing the document from the transportation company. Check the received items against delivery note, and if there is any defect or damage, immediately notify the transportation company. If necessary, you can seek help from ATESS Customer Service department.



Note:

ATESS HPS5000TLS/HPS7500TLS/HPS10000TLS can only be stored when it is stopped and all the doors are closed in a dry room to protect the internal circuits against dust and moisture.

2.4 . Transportation

Transportation should follow the transportation methods described in the user manual. The inverter's weight and center of gravity should be taken into account during transportation. The center of gravity is marked on the box.



Caution, risk of danger

During transportation, lifting equipment and personnel must be qualified. The inverter should be placed vertically and the inclination cannot be more than 10 degrees. It is not allowed to place the inverter upside down or transport in a horizontal position. Incorrect lifting and transportation can lead to serious injury, property loss and damage to the inverter.

2.5 Installation

Hybrid storage inverter is with IP54 protection level, and designed for wall-mounting installation, installation of the inverter must be according to information included in this manual especially on Chapter 4.

2.6 Repair and maintenance



Repair and maintenance can only be carried out after disconnecting the DC and AC for at least 20 minutes. Only professional technical personnel are qualified for the operation.

Disconnect breaker

Open PV and BAT switch to disconnect inverter from battery and solar array, and open GRID input and GRID output switch to disconnect inverter from grid. Make sure inverter cannot be connected accidentally. Test with multi-meter and make sure all switch and breaker open and without voltage potential. Even inverter is disconnected from grid and battery, PV, some component inside inverter such as capacitor is still with energy stored and is dangerous when capacitor discharge, so at least 20 minutes later check with multi-meter that BUS line is without voltage potential, then operate accordingly.

Maintenance and modification

Only personnel with ATESS authorization are qualified for the maintenance and modification. And to ensure personal safety, use original accessories provided by the manufacturer only. Otherwise, electrical safety and EMC might not comply with the required standard.

Function and safety parameters

Don't change the parameters of the inverter without authorization from the local utility and ATESS Energy Technology Co., Ltd. Otherwise, it might lead to injury or equipment damage and the warranty of the inverter will be voided.

2.7 . Inverter EMC and noise level

Electromagnetic compatibility (EMC) is the requirement for electrical equipment that it can operate normally in the electromagnetic environment and does not cause unacceptable environmental impact itself. So EMC represents the quality characteristics of electrical equipment:

Hybrid inverter can generate certain noise and electro-magnetic radiation, according to EMC and noise level, the inverter is qualified for installation and operation in industrial environment, long time stay around the inverter is not recommended during operation.

2.8 . Important note



Information

Note 1: Static electricity can cause damage to the inverter

Electrostatic discharge may cause unrecoverable damage to inverter internal components! When operating the inverter, operator must comply with anti-static protection regulations!

Note 2: Restriction

The inverter cannot be directly used to connect the life support equipment and medical equipment!

Item 3: Precautions

Make sure installation tools or other unnecessary items are not left inside the inverter before starting up.

Item 4: Maintenance notice

Maintenance can only be carried out after the inverter totally discharged.

3 Product description

3.1 Energy Storage system

ATESS HPS5000TLS/HPS7500TLS/HPS10000TLS hybrid inverter is designed for energy storage system, it converts DC current generated by battery bank into AC current and feed into the load/grid, also it can take power from solar inverter or grid to charge battery .

3.2 Circuit diagram of the inverter

ATESS HPS5000TLS/HPS7500TLS/HPS10000TLS hybrid inverter is designed for energy storage system, it converts DC current generated by battery bank into AC current and feed t into the load/grid, also it can take power from solar inverter or grid to charge battery .

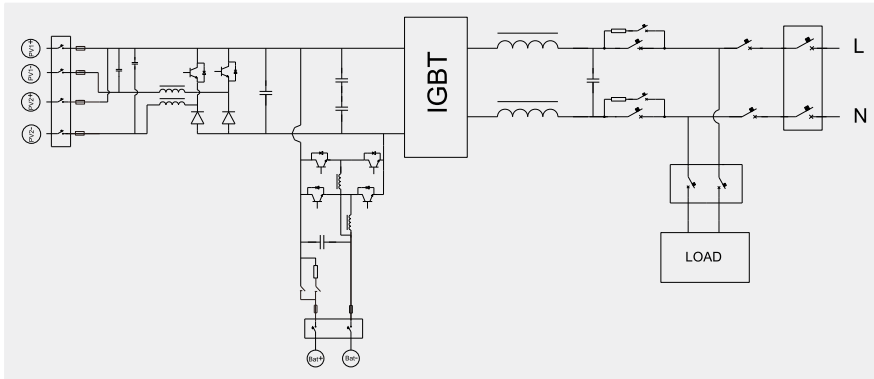

Figure 3-2-1 ATESS HPS-TLS circuit diagram

3.3 Product specification

3.3.1 Input parameter

Inverter model	HPS 5000TLS	HPS 7500TLS	HPS 10000TLS
Max DC input power	6.25kW	9.4kW	12.5kW
Max DC input voltage	600V	750V	750V
MPPT voltage range	125V-550V	370V-600V	370V-600V
Battery input voltage range	85V-500V	280V-720V	280V-720V
Battery input current	20A	21.5A	25A

3.3.2 Output parameter

Energy storage controller model	HPS 5000TLS	HPS 7500TLS	HPS 10000TLS
Rated AC output power	5kW	7.5kW	10kW
Max AC output current	22A	33A	44A
Rated AC output frequency	50/60Hz		
Rated AC voltage	230Vac		
Power factor	0.8lagging-0.8leading		

3.3.3 Important notes

Note 1:usage restrictions



A. if the load connecting to HPS10000TLS inverter is impact load, HPS10000TLS can only supply power to 2P impact load at most, such as 2P motor.

B. HPS7500TLS and HPS5000TLS inverters can only power 1P impact loads, such as 1P motors.

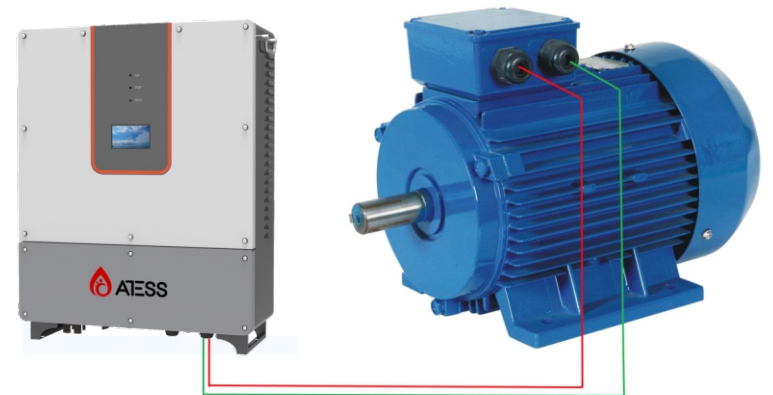

3.4 The layout of the main parts

3.4.1 External layout



Figure 3-4-1-1 Inverter appearance

No.	Name	Description
1	Display	Inverter setting, browsing and operation status display
2	PD compartment	For power input and output installation and maintenance
3	Cable inlet and outlet	For input and output power cable connection
4	Heat dissipation screen	For hot and cool air ventilation

Figure 3-3-1 Part description

Indicator

There are 3 LED indicators on the inverter which is used to display the current status of the inverter.



Figure 3-4-1-2 LED indicators

LED	Description
RUN	Lit when inverter is in normal operation
STOP	Lit when inverter is stopped
FAULT	Lit when inverter is in fault condition

Cable inlet and outlet



Figure 3-4-1-3 Inverter cable inlet and outlet

Port	Description
SWITCH I	PV DC switch
INPUT I	PV cable gland
BAT/LOAD/GRID	Cable gland for input and output

Communication port

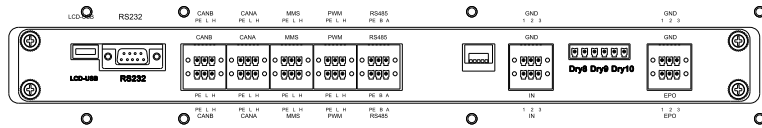

3.4.2 Inner component layout

Inner component layout is shown in below figure:

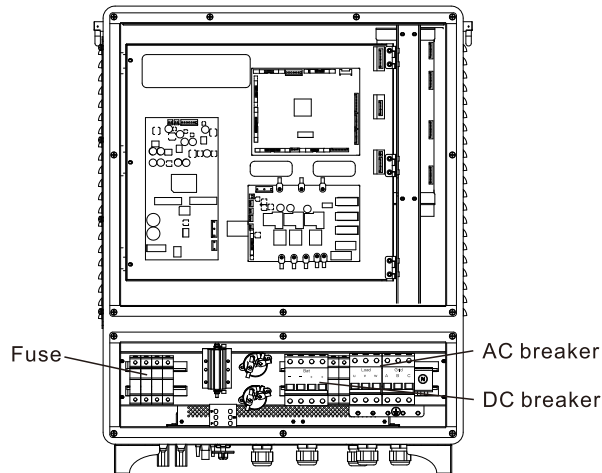

DC/AC breaker

The AC main switch can be used to disconnect the AC side of the inverter from the grid. The DC main switch can be used to make the DC side of the inverter disconnected from the battery assembly. If you use AC main breaker under load, the components of the inverter will be subjected to considerable stress. Frequent use of the AC main switch can result in individual components damage due to stress and may cause inverter failure.

Fuse

There is a mark on the fuse holder, the mark turns red indicates that the fuse is damaged; professional technicians are required to check the cause of the damage of the fuse and then replace the fuse.

3.5 working mode

HPS5000TLS/HPS7500TLS/HPS10000TLS is designed with flexible working modes:

3.5.1. Off-grid mode

- (1) When PV power is higher than load power, PV supply priority to load power, then to the battery charge.
- (2) Battery discharge automatically when PV power is lower than load power.

3.5.2 Grid-connected load priority mode

- (1) Make full use of PV power. When the PV power is insufficient, the battery is given priority for the load, and the second grid is used for the load.
- (2) This mode has two situations: anti-backflow and no backflow prevention. PV power meets charging power and load to prevent power feeding to grid.
- (3) Working status:
 - A. When the PV power is greater than the load power, the PV preferentially supplies power to the load, and the residual power is charged to the battery;
 - B. When the PV power does not meet the load, the battery is automatically discharged. If the battery is discharged to the undervoltage protection point, the PV and the grid together supply power to the load. To protect the battery, the PV side will use a small amount of power to charge the battery, and the battery can be recharged to a certain extent to restore power.

3.5.3 On-grid backup priority mode

- (1) Grid supplies power to load and charges battery when PV power insufficient.
- (2) When the back-flow-prevention works, PV power can meet battery charge and load power.
- (3) operation state
 - A. PV supply priority to the load, the remaining to load and grid when PV power is higher than load power
 - B. When PV power is lower than the charging power, PV supply priority to battery, the grid supplies to load and battery.

□ 20% If battery is not discharged at this mode or inverter switched to other mode, float charge after one week, then discharge battery

3.5.4 On-grid economic priority mode

(1)At this mode, the inverter can prevent the current from flowing back by default, PV will only need to meet battery charge and load power.

(2)Valley price: working logic is the same to the backup priority mode's. PV and grid supply priority to battery, the remaining to load.

(3)Fair price:

A. Battery can neither discharge nor be charged by grid.

B.PV power supply priority to load, the remaining to battery when PV power is higher than load power.

C. When PV power is lower than load power, PV and grid supply to load, PV does not charge battery

(4)Peak price:

A. Grid will not charge battery.

B. When PV power is higher than load power, PV supply to load , the remaining to battery.

C. When PV power is lower than load power, there are two conditions:

a. When battery voltage is normal, PV and battery supply to load.

b. When the battery is under voltage, battery will not discharge, PV and grid supply to load only, not to battery.

3.5.5 On/Off-grid switch

Operation logic: When grid power on, HPS can switch into on-grid mode automatically; when grid power off, HPS can switch into off-grid mode automatically.

3.5.6 Fault mode

When the Hybrid energy system fails, the inverter will immediately disconnect the AC/DC contactor and enters into the fault mode, so as to ensure the safety of the system. Inverter continuously monitors fault status and will not enter charge and discharge mode until the fault is eliminated.

3.5.7 Permanent fault mode

When the Hybrid energy system is in serious failure, the inverter will immediately disconnect the AC/DC contactor and enters into the Permanent fault mode, so as to ensure the safety of the system. For example: inverter module failure etc. please contact your local dealer or ATESS directly when inverter enters permanent fault mode, repairmen on site is not allowed without authorization of ATESS.

3.6 Battery setting

Battery is an important part of energy storage system, strict protection is needed in the whole operation process. Protection threshold need to be set on HPS10 to ensure safe operation of battery, parameters including: battery quantity and unit quantity, capacity, charge current, discharge current, over voltage protection, under-voltage protection and so on. Battery parameter setting need to be done by professional personnel. Improper setting of battery will affect the normal

3.7 Storage

If there is a long time before installation or operation, the ATESS HPS5000TLS/HPS7500TLS/HPS10000TLS should be stored appropriately.

- > The packaging should be restored to its original state;
- > Retain the desiccant in the packaging.
- > The ATESS HPS5000TLS/HPS7500TLS/HPS10000TLS can only be stored when it is stopped and all the doors are closed in a dry room to protect the internal circuits against dust and moisture.
- > Storage temperature range: -40~55 ℃
- > Storage relative humidity range: 5 %~95 %
- > Operating temperature range: -25~55 ℃
- > Operating relative humidity range:5 %~95%
- > Max. altitude:2000 m



CAUTION

- Strictly prohibited storage without packing!
- Avoid storage in direct sunlight!
- Keep upright and no stacking on top of the crate.

3.8 Packaging information

No.	Name	Unit	Quantity
1	Inverter main unit	pcs	1
2	Wall-mounting accessory	set	1
3	Expansion bolt	set	6
4	user manual	pcs	1
5	certificate	pcs	1

Table 3-8-1 Packaging information

4.1 Installation condition requirements

To ensure normal operation of the machine, the installation environment is required as follows:

A. The wall for mounting HPS should be solid and able to bear the weight of HPS in the long term.

B. Installation space should be sufficient to cover HPS dimension, HPS dimension and installation gap please see below photo:

C. Do not install HPS on flammable or heat vulnerable materials or buildings

D. Do not install HPS in a space without good ventilation or dusty, it will cause low cooling fan efficiency, then reduce HPS efficiency, the fan and fan cover should be checked and cleaned every 6 months

E. To avoid overheat and power derating, please do not expose HPS under the sun

F. Environment temperature around HPS should be -25°C ~ 55°C

G. HPS can be installed on vertical or tilted surface as shown in below figure:

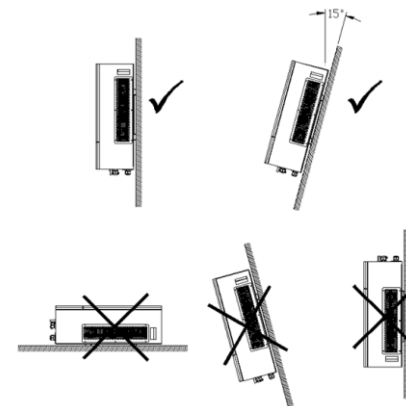

H. Please ensure sufficient space

I. Do not install HPS beside TV antenna, mobile network devices or lightning rods to ground.

J. Do Not install HPS in residential area

K. Do not install HPS in area within reach of children

4.2 Installation environment

Although HPS is with IP54 protection level, it is not recommended to install it under direct sun or direct rain/snow to ensure long term performance, below installation environment for reference:

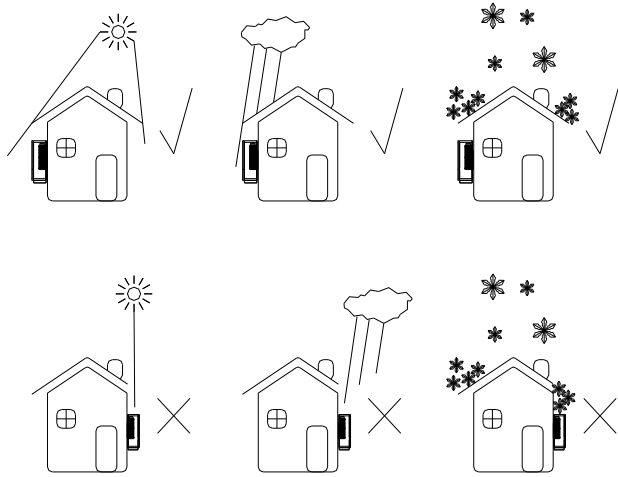

To avoid inverter life span decrease, it is recommended to install shading shield on top of inverter, distance between inverter and top shield please refer to below figure 3.8:

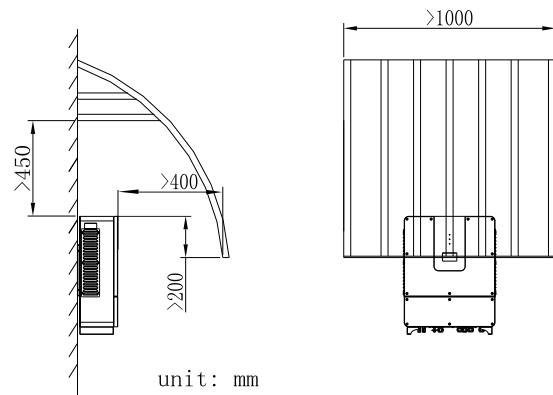

4.3 Space requirement

When installing HPS, reasonable distance should be kept for maintenance and ventilation, please refer to below figure:

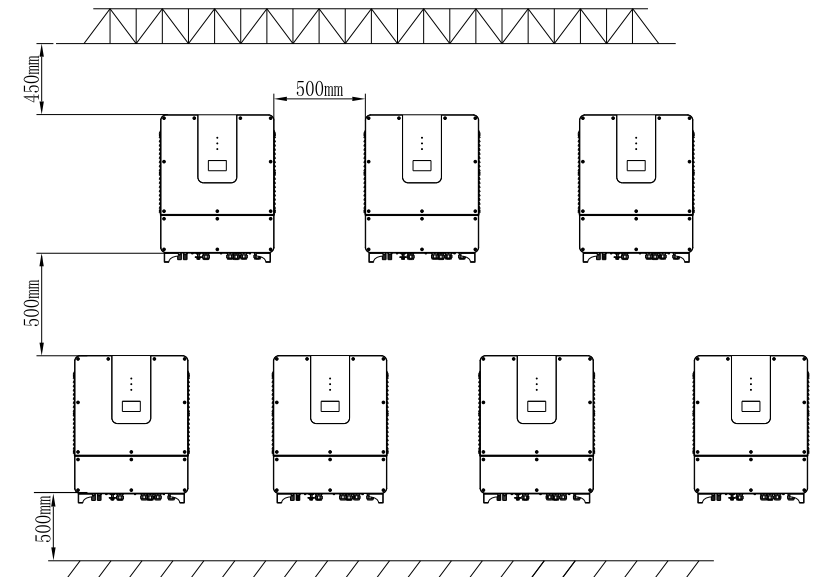

Warning:

When environment temperature is too high, inverter derating is normal operation, but if derating occurs frequently, please check inverter heat dissipation surface or consider to move inverter to area with better ventilation. If fan is dirty please clean, if inverter inner fault please seek for professional service.

4.4 Tools and spare parts required for whole machine installation

Tools and spare parts required for installation is as follows:

- Hoisting crane, forklift or fork lift truck (with the capacity for bearing the weight of the inverter)
- Torque wrench
- Screwdriver
- Wire stripper
- Terminal crimping machine
- Heat dryer
- Megger and multimeter

4.5 Mechanical installation

4.5.1 Installation of wall-mounting kit



Before installing the wall-mounting kit, please check and make sure there's no electric cable and gas pipe in the location of installation.

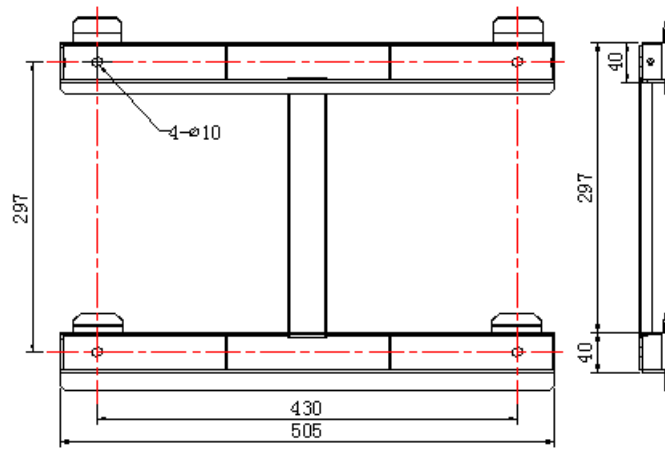

Figure 4-5-1-1 installation gap

Steps:

- A: Drill hole according to location of the wall-mounting bracket screw hole, total 6
- B. Refer to figure 4 for installation of wall-mounting bracket

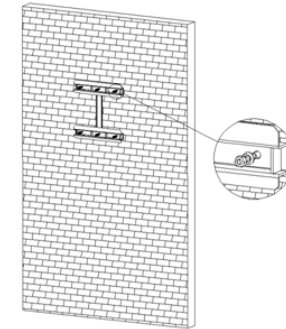

Figure 4-5-1-2 bracket installation



Note: wall-mounting bracket must be installed first before installing HPS

4.5.2 Installing HPS

- A. keep the inverter balance when hanging it to the bracket

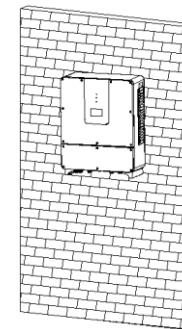

Figure 4-5-2-1 Hanging of inverter

4.6 Electrical installation

4.6.1 Input and output requirements



NOTICE
Caution, risk of danger

- There is a danger of electrical shock of high voltage in inverter's operation; only electricians of professional skills can operate.
- All connections with this equipment shall be done under non-voltage state.
- The inverter may be damaged if input or output terminal is incorrectly plugged.

Failure of acting upon this information may cause serious

1) Battery

Battery string voltage should not exceed 720V, or else inverter will be in faulty mode

2) Three-phase grid

Inverter will continuously inspect whether the grid satisfy the grid connected conditions. The following is the grid limit for satisfaction of local Grid connected conditions (requirements in different countries may vary, the value can be setup and please refer to local grid connected regulations for details), and the grid is three-phase grid. Meanwhile, it shall be permitted by local power supply department before install Grid-connected inverted power.

Model	HPS5000TLS/HPS7500TLS/HPS10000TLS
Grid Voltage Limit	210V~250V
Grid Frequency Limit	47HZ-51.5HZ/57HZ-61.5HZ

Cable (Cu)	Cable Diameter Requirements (mm ²)	Aperture
Model	HPS5000TLS/HPS7500TLS/HPS10000TLS	
PV +/-	input cable with each at least 4 mm ²	Φ5,5N*m
BAT +/-	cable with each at least 6 mm ²	Φ5,5N*m
Grid input A B C	input cable with each at least 4 mm ²	Φ5,5N*m
Grid input A B C	input cable with each at least 4 mm ²	
Communication Wire	0.75mm ² , shielded Twisted pair is recommended	/
Earth Wire	More than 6 mm ² . Green and yellow is recommended	Φ5,5N*m

4.6.2 preparation before cable connection

Before wiring, you need to open the front door of the energy storage controller. The specific steps are as follows:

Step 1: Turn off the AC and DC air. As shown in the figure below, the PV switch is in the "OFF" state.



4.6.3 DC side wiring



CAUTION!
Caution, risk of danger

The positive and negative of the battery shall not be connected in reverse. A multimeter shall be used to determine the polarity first, and then connect into the corresponding input ends of the inverter. Specific procedures are as follows:

Step 1: Cut off the distribution circuit breaker at the DC side, and ensure that no voltage on the wire at DC side.

Step 2: Confirm the battery positive and negative voltage within range with a multimeter.

Step 3: Confirm the negative and positive pole with a multimeter

Step 4 Peel the insulation layer of cable

Step5: fix cable lug

1. Place the stripped copper core into the crimping holes of the cable lug
2. Press the cable lug with the terminal crimping machine. The number of crimps should be more than two

Step 6: fix heat shrinking tube

1. choose heat shrink tube according to cable size, and cut about 5cm
2. fix the tube to cable, cover the lug hole
3. use air heater to blow the tube and make it shrink

Step 7: Connect the "Bat+" end of the energy storage controller to the positive terminal of the battery pack with a cable.

1. Pass the cable through the PG waterproof connector.
2. Secure the copper noses at the ends of the wiring to the "Bat+" end of the energy storage controller and the positive terminal of the battery pack.
3. Fasten the bolt with a screwdriver or wrench

Step 8: Connect the "Bat -" end of the energy storage controller to the negative terminal of the battery pack by cable according to the method of step 7.

Step 9: Connect the "PV+" end of the energy storage controller to the positive pole of the battery board by cable according to the method of step 7.

Step 10: Connect the "PV-" end of the energy storage controller to the negative pole of the battery board by cable according to the method of step 7.

Step 11: Make sure the wiring is secure; tighten the PG waterproof connector

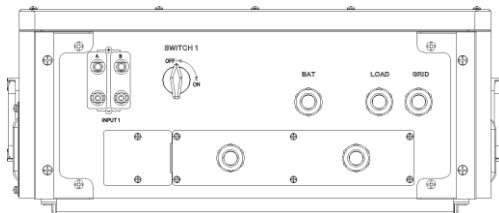

4.6.4 AC side wiring



CAUTION!
Caution, risk of danger

When connecting the AC grid, cut off the circuit breaker at the AC side to ensure that the AC wire connecting to terminals has no electricity.

Connect AC grid:

1) Cut off the circuit breaker at AC side, to ensure that the AC wire connecting to terminals has no electricity. Confirm it with a multimeter.

2) confirm the phase sequence of grid

3) peel the insulation layer of cable

4) fix cable lug

5) fix heat shrink tube

1. choose heat shrink tube according to cable size, and cut about 5cm

2. fix the tube to cable, cover the lug hole

3. use air heater to blow the tube and make it shrink

6)

1. Connect the L marked at "Grid" of HPS with "L" of the grid .

2. Connect the N marked at "Grid" of HPS with "N" of the grid.

7) same with step 6, connect load cable L□N to the "L"□"N" port of HPS Load.

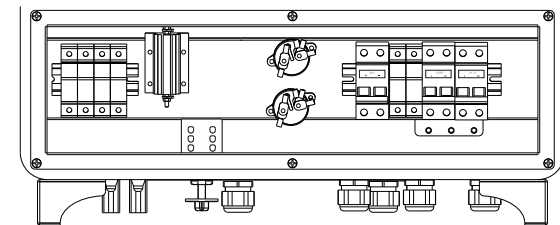

Figure 4-6-1-1 AC output cable connection

4.6.5 Earthing

Inverter must be earthing well for safety; Please make sure of the connection between PE in power distribution cabinet and PE copper in the inverter good; and make sure the earthing cable more than 6mm² and the earthing resistance must below 4 ohm.

Inveter earthing busbar please refer to above photo cable inlet and outlet are on the bottom of inverter, after finishing connection, tighten the cable tighten gland.



4-6-1-2 cable inlet and outlet



Note: the PE busbar is for grounding inside inverter, please do not change to avoid electric shock risk

4.7 Communication

The HPS series hybrid energy storage system has multiple communication modes. When users need to monitor the operation status of the energy storage and discharge system, RS485 serial port or CAN communication mode can be used for power supply.

4.7.1 RS485

Users can directly use the RS485/RS232 converter for host computer communication. The HPS communicates with the HPS through RS485, and finally communicates with the PC through the RS485 to RS232 datalogger, runs the monitoring software in the PC, and monitors the running status of the single/multiple energy storage controllers in real time.

Rs485 communication line uses terminal blocks at both ends, and RS485 communication lines are made by parallel connection of terminals at both ends. The length should not exceed 1000 meters. As shown in Figure 4-7-1-1



Figure 4-7-1-1

4.7.2 CAN communication

Rate of CAN communication is between 100K and 500K, and the shielded twisted pair is used for communication to ensure communication quality.

4.8 Installation inspection

Before the inverter is put into operation, it shall be inspected for installation. Two working men or more shall inspect to ensure correct installation of all installation according to the following table.

Mechanical inspection

- Inverter's bottom is fixed, and the support is stable and reliable.
- Enough space is left around inverter.
- The ambient temperature, humidity and ventilation satisfy requirements.
- Smooth flow of cooling air.
- Complete and reliable sealing protection of cabinet.
- No deformation and damage to inverter.

Electrical Installation Inspection

- Complete and firm grounding of inverter.
- Grid voltage matching the rated input voltage of inverter.
- Correct phase sequence of grid connection, and tightening torque meeting requirements.
- Correct connection of DC input anode and cathode, and tightening torque meeting requirements.
- Correct connection of communication lines, and maintaining a certain distance to other cables.
- Mechanical Installation Items Inspection
- Other Inspections
- All useless conductive parts tied with insulating ribbon.
- No tools, spare parts, conductive dust generated from drilling or other matters left inside the cabinet.
- No condensed humidity or icing inside the cabinet.

Table 4-8 Installation Inspection List

The chapter will introduce the procedure of pilot operation, including checking battery voltage, input and output connecting, other preparation working.

5.1 Relevant requirements

Before pilot operation, the installation conditions of the equipment shall be examined thoroughly, in particular whether voltages at DC and AC ends are consistent with inverter's requirements, and whether the polarity etc. are correct. Inspect if the system connection meets requirements in relevant standards or codes and if the system is grounded well.



CAUTION!

Before pilot operation, all switches at AC side and DC side shall ensure to be cut off.

5.2 Inspection

5.2.1 Inverter inspection

Before power on the inverter, please carry out inspections as the following procedures:

Step 1: Inspect inverter's installation and wiring conditions based on the Installation Inspection List in Table 4-8;

Step 2: Ensure the AC&DC circuit breakers are cut off;

5.2.2 Grid voltage inspection

Inspect whether the three phases of the inverter is correctively connected with the three phase sequence of the grid. Inspect whether the line voltage and frequency are within the prescribed range, and record the value. If possible, measure the phase THD (Total Harmonic Distortion), and inspect the curve. If distortion is serious, the inverter may fail to operate.



CAUTION!

When connecting the load, make sure that the three-phase of the load is corresponding to the three-phase of the HPS, otherwise it will cause the motor to reverse.

5.2.3 DC side voltage inspection

The DC side consists of two parts, from the confluence box or the DC distribution cabinet to the HPS and from the storage battery to the HPS. Ensure that the direct current from the confluence box or DC distribution cabinet is connected to the PV terminal of HPS and is in sequence.

- Make sure the DC input polarity is correct;
- Measure and record each DC (open circuit) voltage. The voltage value of each channel should be almost the same and should not exceed the maximum allowable DC voltage value.
- Battery voltage check, battery parameter setting check

5.3 Power on steps

First power-on

Step 1: Close AC circuit breaker

Step 2: Close DC circuit breaker

Step 3: PV DC switch to ON position

Step 4: Click start on inverter display and wait till 'grid connecting'

Note: when system is powered, 60S later about display will lit

Manual turn-off

During operation, you can click the shutdown button on the LCD, at this time the inverter stops working and stops sending power to the grid



Warning:

- After manually shutting down, you must press the power button on the LCD, otherwise cannot start automatically.
- Still powered after manual shutdown

5.4 Pilot operation completion

The following procedures shall be carried out after the inverter is normally in operation.

Procedure 1: Inspect whether abnormality exists in the inverter, such as excessive noise, excessive heat, abnormal smell or smoke.

Procedure 2: Measure whether inverter voltage, current and THD are stable.

Procedure 3: Operate LCD control panel and inspect whether it displays normally and accurately.

By now, the pilot operation of inverter is fully completed, and we can enter the daily operational maintenance.

5.5 Power off steps



CAUTION!

After the inverter is completely powered off, the general DC switch at battery side and the Grid switch at grid side still maintain voltage. If operations are needed, please be sure to cut off the outer power completely, and wait for not less than 20 minutes

1. Click the OFF button on LCD or turn the off-on knob from ON to OFF;
2. Cut off DC SWITCH;
3. Cut off GRID switch and load switch



During the power-off process, the energy storage controller sends an alarm as normal. You can continue the power-off step

6 GUI instruction

6.1 LCD display screen introduction

User can view the information of the inverter operation on the LCD touch screen, as well as setting the operating parameters. In order to facilitate the operation, a menu is provided below.

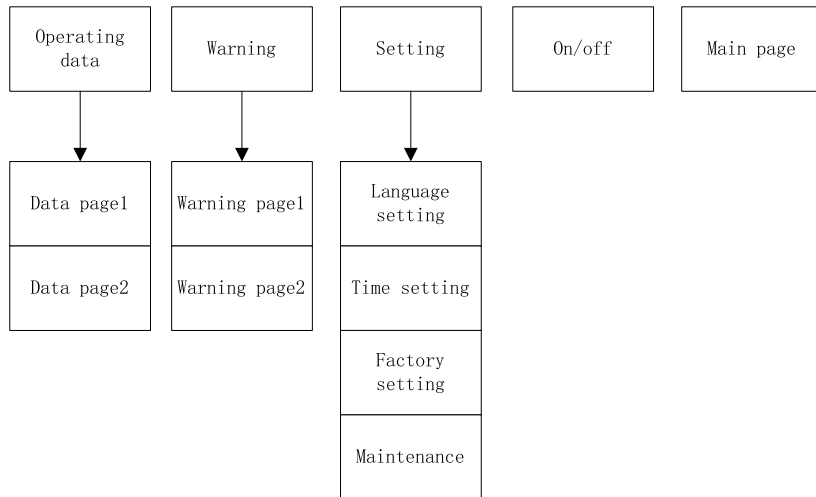

Table 6-1 ATESS HPS-TLS LCD Menu

After the LCD is powered on, go directly to the home page of the interface. At this time, wait for the internal initialization of the machine for about 1 minute (If there is no data refresh after more than 2 minutes, the serial communication between the LCD and the control board is faulty). At this time, you can start to operate the relevant buttons for information review and parameter setting.

The top of each page shows the communication status of the LCD and the energy storage controller, the station number of the communication terminal where the energy storage controller is located, and the system time. There are five common function buttons at the bottom of each page: "Run Data", "History Information", "System Settings", "Power On/Off", "Home Page". With these five commonly used keys, users can operate quickly and easily. On the left side of the interface, the submenu buttons corresponding to the above five commonly used keys are displayed, and the selected buttons are marked in green.

6.2 LCD operation

6.2.1 Initialization

Initialization interface: The initialization interface will be divided into two parts, the terminal is initialized.

End initialization: The initialization time is about 60 seconds. When the [Homepage] data is refreshed, you can perform related operations.

6.2.2 Main page

You can enter this page by clicking the [Home Page] button below any other interface. In this page, there are mainly: the operating state of the energy storage controller, output power, model, input and output voltage, current and other information. Switch to other pages with the usual function keys below.

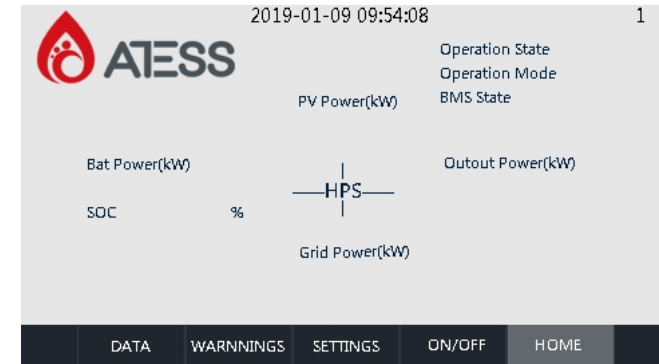

6.2.3 Switch on/off page

You can enter this page by clicking the [Switch on/off] button in any other interface. There are the on button, the off button. Used to select power on or off operation. After selecting, select [Yes] / [No] in the pop-up sub-window to confirm.

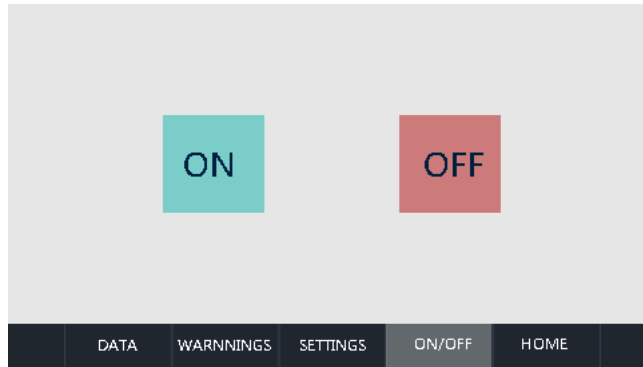

Language Settings: Select language, currently it only supports Chinese, English (default language is Chinese).



Time settings: system time setting (if the date and time displayed on LCD is not inconsistent with the actual date and time, they can be modified here)

6.2.4 System Settings

Click the [System Settings] button in any other interface to enter the sub-menu of "System Settings". Submenus are: language settings, time settings, device information, device maintenance. The corresponding submenu interface can be accessed through the left button. The "Language Settings" interface is accessed by default. (Device Maintenance: This item is only open to professional maintenance personnel due to security concerns.)

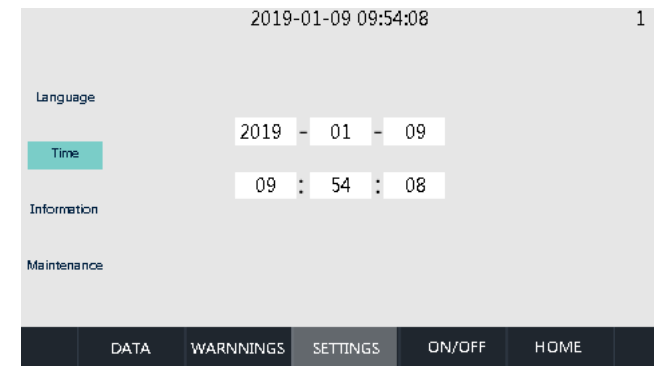
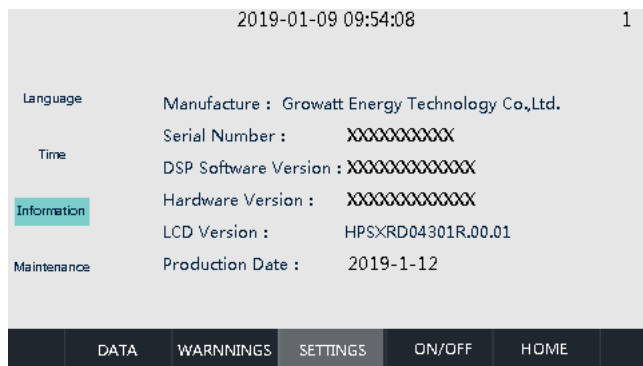

Device Information: This page shows the manufacturer, inverter serial number, hardware and software version information, and the date of manufacturing.



Maintenance: the interface requires a password to login. It is for electrician and maintenance personnel who are fully familiar with the structure and working principle of the DC grid system only, in order to avoid damage to personal safety and the inverter.

6.2.5 Alarm Information

You can enter this page by clicking the [Alarm Information] button below any other interface. This page mainly records the alarm information of the last 20 energy storage controllers. More common fault information including time and alarm information is shown in Table 6.3.1.

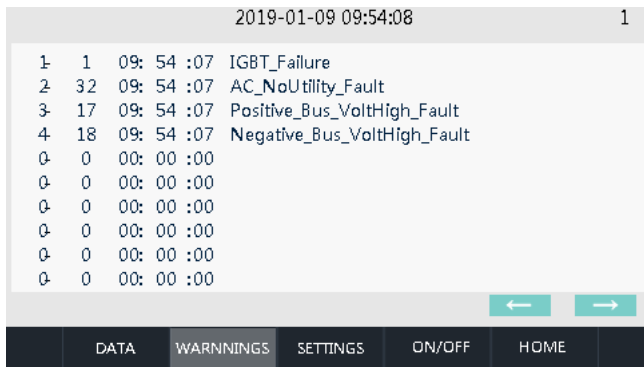

6.2.6 Operation data

You can enter this page by clicking the [Run Data] button below any other interface. This page mainly displays the current energy storage power generation parameters and real-time data including grid voltage, grid frequency, grid current, DC input voltage, DC input current, chassis temperature and total power generation time, etc. (real-time update).

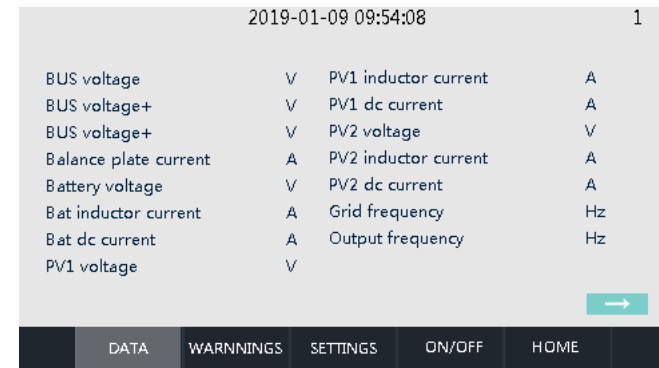

6.3 LCD display information schedule

6.3.1 General history failure table

No.	Description
1	DC_Inverse_Failure
2	IGBT_Failure
3	EEPROM_Write_Failure
4	EEPROM_Read_Failure
5	AC_MainContactor_Failure
6	AC_SlaveContactor_Failure
7	GFDI_Failure

No.	Description
8	GFCI_Failure
9	DC1_VoltHigh_Fault
10	DC2_VoltHigh_Fault
11	DC1_CurrHigh_Fault
12	DC2_CurrHigh_Fault
13	DC1_Insulation_Fault
14	DC2_Insulation_Fault
15	DC1_OCP_Fault
16	DC2_OCP_Fault
17	INT_DC1_OverVolt_Fault
18	INT_DC2_OverVolt_Fault
19	INT_DC1_OverCurr_Fault
20	INT_DC2_OverCurr_Fault
21	IGBT_Module1_Fault
22	IGBT_Module2_Fault
23	L1_OCP_Fault
24	L2_OCP_Fault

No.	Description
25	INT_L1_OverCurr_Fault
26	INT_L2_OverCurr_Fault
27	AC_NoUtility_Fault
28	AC_GridPhaseSeque_Fault
29	AC_PLL_Fault
30	AC_Volt_Unbalance_Fault
31	AC_Curr_Unbalance_Fault
32	AC_WU_OverVolt_Fault
33	AC_WU_UnderVolt_Fault
34	AC_VW_OverVolt_Fault
35	AC_VW_UnderVolt_Fault
36	AC_UV_OverVolt_Fault
37	AC_UV_UnderVolt_Fault
38	AC_OverFreq_Fault
39	AC_UnderFreq_Fault
40	AC_GridCurr_DcHigh_Fault
41	AC_L1Curr_DcHigh_Fault

No.	Description
42	AC_L2Curr_DcHigh_Fault
43	AC_GridCurr_High_Fault
44	AC_L1Curr_High_Fault
45	AC_L2Curr_High_Fault
46	AC_Overload_Fault
47	AC_Lightload_Fault
48	AC_BackFeed_Fault
49	LVRT_Fault
50	Module1_OverTemp_Fault
51	Module2_OverTemp_Fault
52	Inductor1_OverTemp_Fault
53	Inductor2_OverTemp_Fault
54	Transformer_OverTemp_Fault
55	LowTemp_Fault
56	EPO_Stop
57	KeyEmergencyStop
58	LcdEmergencyStop

No.	Description
59	Door_Open_Fault
60	AC_MainContactor1_Fault
61	AC_MainContactor2_Fault
62	AC_MainContactor3_Fault
63	AC_SlaveContactor_Fault
64	GFDI_Ground_Fault
65	GFDI_HallSense_Fault
66	GFDI_AirSwitch_Fault
67	GFDI1_Fault
68	GFDI2_Fault
69	RISO1_Fault
70	RISO2_Fault
71	GFCI1_Fault
72	GFCI2_Fault
73	AC_Fuse1_Fault
74	AC_Fuse2_Fault
75	Batt_OverCurr_Fault

No.	Description
76	Batt_OverVolt_Fault
77	Batt_UnderVolt_Fault
78	Batt_UnderVolt_Warning
79	Fault_Feedback_Warning
80	Fan_1_Fault_Warning
81	Fan_2_Fault_Warning
82	Fan_3_Fault_Warning

Table 6.3.1 General history failure table

6.3.2 Severe history failure table

No.	Description
1	Grid AC overvoltage
2	Grid AC undervoltage
3	Grid frequency overfrequency
4	Grid frequency underfrequency
5	DC overvoltage protection
6	AC overvoltage protection
7	AC current imbalance
8	Grid voltage imbalance
9	DC ground fault protection
10	AC side overcurrent protection
11	Low voltage ride through protection
12	Energy storage controller self-fault protection
13	DSP fault protection
14	DC circuit breaker open circuit
15	Energy storage controller temperature alarm
16	Energy storage controller temperature is too high
17	Lightning protection device failure
18	Overheating protection
19	Anti-discharge protection
20	Reverse polarity
21	Normal shutdown
22	Downtime
23	Alarm running

6.3.3 Inverter status

No.	Description
0	wait
1	check
2	Grid mode
3	malfunction
4	Permanent failure
5	Off-grid mode

7 Routine maintenance

7.1 Fan Maintenance

To ensure that the inverter works normally, you need to clean the air filter regularly. When the inverter is working in a high temperature environment, good ventilation and heat dissipation can effectively reduce the probability of load shedding. The inverter is equipped with a cooling fan. When the internal temperature of the inverter is high, the fan works to reduce the internal temperature. If the inverter is low in output due to excessive temperature, the following are possible causes and countermeasures.

- The fan is clogged and the fan and fan cover need to be cleaned.
- The fan is damaged and the fan needs to be replaced.
- Inverter installation location is poorly ventilated, and the appropriate installation location should be selected according to basic installation requirements

Warning:

Do not use a gas pump to clean the fan, as this may cause damage to the fan.

Fan cleaning or replacement:

1. Before cleaning or replacing the fan, please make sure that the DC side and AC side of the inverter have been disconnected.
 - Turn off the DC side switch.
 - Unplug the DC input terminal (user needs to use a tool to disconnect the DC connection).
 - Disconnect the AC open.
2. Rotate the screw counterclockwise with an M4 Phillips screwdriver.

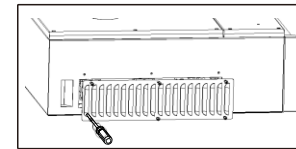

3. Disconnect the fan connector and remove the fan as shown below

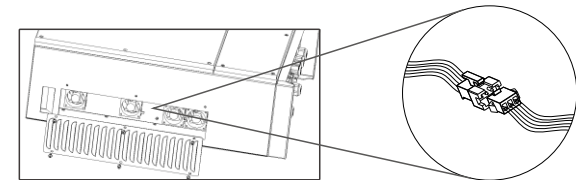

4. Clean the fan and steel mesh or replace the fan

Cleaning fan and steel mesh

- Clean the fan and steel mesh with a gas pump or other tools.
- Remove each fan separately for cleaning if necessary.

Replace the fan

- Use a Phillips screwdriver to remove the fan that needs to be replaced.
- Replace the brand new fan, arrange the wire harness and fix it with a cable tie;

5. Reinstall the fan mounting plate and inverter

7.2 Regular maintenance

Maintenance item	Period
Read data from the datalogger	Monthly
Check if the cable connection is loose	Monthly
Manual inspection of AC and DC circuit breakers	Monthly
LCD stop function	Monthly
Check if there is abnormal noise during the running of the machine	Weekly
Check battery components for abnormalities, swelling, smoke	Daily



The energy storage controller must be regularly maintained to ensure its normal operation and service life. The recommended routine maintenance cycle and work contents are shown in Table 7-2.

7.3 Waste treatment

The energy storage controller will not pollute the environment, and the constituent materials and components of the product will meet the environmental protection requirements. ATESS shall, according to environmental protection requirements, be treated according to local regulations when the energy storage controller is used.

8.1 Specification

Model	HPS10000TL/HPS7500TL
Dimension (W/H/D)	600/730/250mm
Weight	50kg
Environment temperature	-25 °C... +55 °C
Protection degree	IP54
Standby consumption	<20W
Cooling	Forced-air
Noise emission	<65dB(A)@1m
Display	Touch screen
Communication interface	RS485/CAN

8.2 Warranty

The warranty period of this product is one year. If the contract stipulates otherwise, the contract shall prevail. During the warranty period, ATESS products shall promptly present the invoice and date of purchase of the products to ATESS Service personnel during maintenance. At the same time on the product the nameplate logo should be clearly visible, otherwise it will not be repaired.

Warranty condition

ATESS will repair or replace the product free of charge during the warranty period; the faulty machine after replacement shall be owned by ATESS; the customer shall reserve a certain amount of time for ATESS to repair the faulty machine.

Liability exemption

The following circumstances arise, the company has the right not to carry out quality assurance:

Products without the ATESS logo;

The product or component has exceeded ATESS Warranty period;

Failure or damage caused by non-product working environment or incorrect installation, storage and use (such as excessive temperature, too low temperature, too humid or dry, high altitude, unstable voltage or current, etc.) Failure or damage caused by the installation, repair, modification or disassembly of non-ATESS after-sales service personnel, except for after-sales commission;

Failure or damage caused by the use of non-ATESS components; due to accidents or human causes (operational errors, scratches, handling, bumps, improper voltage access, etc.)

Failure or damage, transportation damage; failure or damage caused by force majeure such as natural disasters (such as earthquakes, lightning strikes, fires, etc.); other failures or damages caused by the quality problems of ATESS machines (including components) themselves.