



**SHENZHEN ATESS POWER TECHNOLOGY CO.,LTD**

GROWATT-ATESS Industrial Park, No.23 Zhulongtian Road, Shuitian Community,  
Shiyan Street, Baoan District, Shenzhen

Tel: +86 755 2998 8492

Web: [www.atesspower.com](http://www.atesspower.com)

Email: [info@atesspower.com](mailto:info@atesspower.com)

Revised date: 2024-04-24

044.ZT0024400



**BC30RPB-BC55RPB**  
Energy Storage System  
User Manual

# Foreword

## Legal Notices

---

The copyright of this material belongs to the company. No unit or individual may extract, copy or translate in any way without the written permission of the copyright owner.

Infringement must be investigated.

This manual does not grant the reader any license or right to use any of the marks appearing in this manual without the prior written consent of the company or third party trademark or trade name owner.

This product complies with the design requirements for environmental protection and personal safety. The storage, use and disposal of the product shall be in accordance with the product manual, relevant contract or relevant national laws and regulations.

## Manual description

---

The BC series of energy storage systems provide energy storage for PV users. During the day, the excess power of PV power generation can be stored in the battery. At night or when needed, the stored electrical energy can be used to supply power to the electrical equipment, which can improve the efficiency of PV power generation, peak filling and valley filling, and emergency power backup.

This user manual system details the basic structure, parameters, basic procedures and methods of installation and operation and maintenance of the equipment.

# Contents

## 1 Summarize

- 1.1 Symbol Introduction
- 1.2 Special Instructions

## 2 Safety Precautions

- 2.1 General Safety Considerations
- 2.2 Electrical Safety
- 2.3 Battery Safety
- 2.4 Wiring Requirements
- 2.5 Mechanical Safety

## 3 System Introductions

- 3.1 Introduction
- 3.2 Battery Module
- 3.3 BPU
- 3.4 Battery cabinet

## 4 Operating Environment

## 5 Transportation and Storage Requirements

- 5.1 Transportation and Storage
- 5.2 Transporting

## 6 Device Installation and Configuration

- 6.1 Installation preparation
- 6.2 Tool Preparation
- 6.3 Unpacking inspection
- 6.4 Preparation before installation
- 6.5 Battery module installation
- 6.6 Electrical connections
- 6.7 Post-installation check
- 6.8 Power on
- 6.9 function operation and testing

## 7 Maintenance

- 7.1 Safety instructions for inspection and maintenance
- 7.2 Tools to be used during maintenance
- 7.3 System inspection table
- 7.4 System inspection and maintenance
- 7.5 Liability exemption record

## 8 Common Troubleshooting

- 8.1 Fault and Abnormal State Processing
- 8.2 Annex B

## 9 Annex



# 1 Summarize

# Safety Precautions 2

## 1.1 Symbol Introduction

- BCU: Battery Control Unit
- BMU: Battery Management Unit
- BMS: Battery Management System
- ESS: Energy Storage System
- BPU: Battery Power Unit

BC(Battery Cabinet): Energy storage battery cabinet

 <b>DANGER</b>	This sign indicates safety hazard during operation. Failure to follow such warning information, it will directly lead to serious personal injury or death
 <b>WARNING</b>	This sign indicates a potential hazard during operation. Failure to follow such warnings may result in personal injury or death
 <b>CAUTION</b>	This sign indicates a potential hazard during operation. Failure to follow such warnings may result in personal injury or death

## 1.2 Special Instructions

This manual covers the installation and use of the battery energy storage system product.

Please read this manual before installation.

The energy storage system must be commissioned and maintained by the engineers who had been trained, otherwise it may lead to injury and equipment failure. The resulting equipment damage is not covered by the warranty.

The pictures configured in the manual just for illustrative purposes. If it is not match the actual product, please refer to the actual product.

## 2.1 General Safety Considerations

● The product should be used under the specified working environment (voltage, current, temperature, humidity, etc.), otherwise the product may malfunction. The resulting product malfunction or component damage is not covered by the product warranty.

● Operators should comply with local regulations. The safety precautions in the manual are only intended to supplement local safety regulations.

● It is strictly forbidden to wear items such as watches, BCacelets, bangles, rings, etc. that are easily conductive during operation.

● Special insulated tools must be used during operation.

● The torque wrench should be used to fix the screw and double check the screw with the red and black logo. After the installer confirms that the screws are tightened, please mark black on the screws; the inspector confirms that the screws are tightened, please mark red on the screws.

● Installation or maintenance operations must follow the steps in the specification and manual.

● If you need to touch any conductor surface or terminal, use a meter to measure the voltage at the contact point before contact, and verify that the contact point is voltage-free or voltage within the predicted range.

● If the cable is stored in an environment below 0°C, the cable must be stored in room temperature environment (25±5°C) for more than 24 hours before the cable is used.

● After the product is installed, routine inspection and maintenance is necessary, and replace the faulty components in time to ensure the safe operation of the product.



## 2.2 Electrical Safety

### Grounding Requirements

- When installing the product, the protective grounding wire must be installed first; when the product is removed, the protective grounding wire must be removed at the end.
- Before operating the product, check the product to ensure that the product is reliably grounded ( $\leq 4\Omega$ ). Not well grounding of the equipment may result in personal injury and equipment damage.

### AC and DC Operation Requirements

#### DANGER

The supply voltage of the energy storage system is dangerous ( $>60V$ ). Direct contact the system or indirect contact the system through wet objects can be dangerous.



Incorrect operation may result in accidents such as fire or electric shock.

Before the product is electrically connected, the front-end protection switch of the product must be disconnected.

Before connecting AC power, must ensure that the electrical connections of the equipment has done.

Before connecting the load cable or battery cable, must confirm the polarity of the cables and terminals is correct, prevent reverse connection.

### Anti-liquid Requirement

The installation location of product should be away from the liquid area, prevent liquid from entering the product and causing short circuit, and to ensure that there is no condensation in the room and product.

When liquid enter the room or product, turn off the power immediately and notify the manager.

## 2.3 Battery Safety

### Basic Requirements

#### DANGER

Wear protective tools such as helmet, insulated shoes, gloves, etc. before installation, maintenance or operation the product.

- Pay attention to the safety protection of the battery to avoid collision and falling, when installing, maintaining, and operation the product.
- The wiring circuit should be kept disconnected during installation, maintenance.
- Tighten the cable according to the torque in the manual, to prevent poor contact and cause heat or even damage the product.
- It is strictly forbidden to damage the battery explosion-proof valve or exhaust valve, otherwise it will cause electrolyte leakage.
- Make sure that the installed battery is the same model.
- Always dispose of used batteries in accordance with local regulations.
- The storage environment of the battery should be free from direct sunlight or rain, dry and well ventilated, and the surrounding environment is clean and away from fire.

#### DANGER



> Do not allow anyone or animals to swallow any parts of the battery or the contents of the battery.

> Do not pierce the battery with nails or other sharp objects.

> Do not put the battery into fire or expose it to high temperatures for a long time, as this may cause a fire.

> Lithium batteries are not allowed to be charged at low temperatures ( $<0^{\circ}C$ ).

> If the model of the replacement battery is incorrect, there is a safety hazard.

#### WARNING

- > Do not immerse the battery in water. When it is not in use, it should be placed in a cool and dry environment.
- > Do not use or leave the battery near hot and high temperature sources such as fire, heaters, etc.
- > Forbidden to reverse the positive and negative terminals of the battery during use.
- > Forbidden to connect the positive and negative terminals of the battery directly with metal, resulting in short circuit of the battery.
- > Forbidden to transport or store batteries with metals such as hairpins, necklaces, etc.
- > Forbidden to strike or throw, trample or bend the battery.



#### Battery Short Circuit Protection

##### DANGER

The battery cell and battery system (module, pack, cabinet, system) circuit must not have any form of short-circuited, otherwise short-circuit may cause fire and may cause personal injury.

If possible, disconnect the battery connection before operation.

#### Battery leakage electrolyte protection

#### CAUTION

Excessive battery temperature can cause battery deformation, damage, and electrolyte spillage.

When the electrolyte of the lithium battery is found to leak, the skin and eyes should be prevented from directly contacting the electrolyte. If there is contact, use plenty of water to clean the area and contact doctor for help.



#### Charging

- Charging current shall not exceed the maximum charging current in the specifications. Otherwise it would cause the problem in charge and discharge performance, mechanical performance and safety performance.
- Charging voltage shall not exceed the maximum charging current in the specifications. Otherwise it would cause the problem in charge and discharge performance, mechanical performance and safety performance.
- Batteries must be charged within the ambient temperature range of 0°C~45°C.
- Forbidding reverse charge. Battery should be connected correctly. It is strictly prohibited to reverse charge. Otherwise it will cause the battery scrap and produce safe hidden trouble.

#### Discharge

- Discharge current shall not exceed the maximum charging current in the specifications. Otherwise it would cause dramatically capacity loss and overheating.
- Batteries must be discharge within the ambient temperature range of -20°C~55°C.
- Forbidding over-discharge. Battery management system should be installed to prevent over discharge during the usage. Over discharge will cause the battery scrap and produce safety hazard. It is necessary to state that for the battery not used for a long time, it may over discharge due to the self-discharge characteristics. To prevent the occurrence of over discharge, the battery should be regularly charge and the voltage should be remained above 3.2 V.

#### 2.4 Wiring Requirements

- Cable used in high temperature environment, will cause the insulation aged or damaged. Thus the cable should be kept at a sufficient distance from the DC bus bar, splitter, and fuse.
- Signal cable and power cable should be routed separately ( $\geq 60\text{cm}$ ).
- User-supplied cables should meet the VW-1 test requirements.
- No cable is allowed to pass behind the air outlet of the power module in the cabinet.

## 2.5 Mechanical Safety

### Removing Heavy Objects Safely

- When carrying heavy objects, be prepared for weight bearing to avoid being crushed or sprained by heavy objects.
- Generally, it's forbidden to transport the heavy product by one person.
- Wear protective gloves when handling product by hand to prevent your hands from being cut by sharp corners.
- When transporting with a forklift, the forklift fork should be in the middle position to ensure symmetry. Do not excessively bump and tilt during handling. The angle of the left and right tilt of the equipment during loading or unloading should not exceed 15°. In order to avoid tipping over, please fasten the product to the forklift with a rope before moving, and take care when moving. Be careful to move the product to avoid damage caused by any impact or drop.

## 3.1 Introduction

The BC Series energy storage system uses a lithium-iron phosphate battery equipped with battery management system (BMS) designed for industrial and commercial energy storage applications. During the day, the excess PV power can be stored in the battery. At night or when needed, the stored electrical energy can be supplied to the electrical equipment, which can improve the efficiency of PV power generation, peak-shaving, and emergency power backup.

### Comply with international standards and certifications

Lithium batteries have passed CE, UN38.3 and other certifications.

### High reliability system

Adopt high-performance processor and ensure the stable operation of the system based on the three-layer management mode.

Real-time monitoring of system conditions, providing short-circuit protection, reverse connection protection, high-voltage protection, low-voltage protection, charging over-current protection, discharge over-current protection, over-charge protection, over-discharge protection, high-temperature protection, low-temperature protection, cell balancing and other functions.

### Powerful communication features

Configure a variety of communication interfaces: USB, RS-485, 4G (optional), CAN, you can know the battery working status at any time through the host computer

## 3.2 Battery Module

### 3.2.1 Battery module front panel schematic

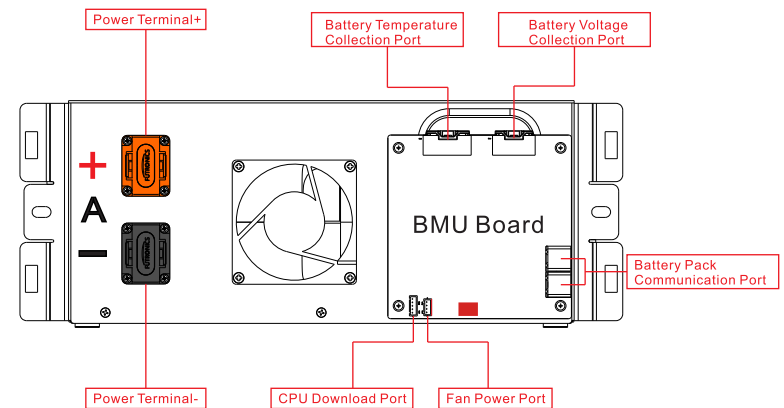

Figure-1 Battery A module panel appearance

Power Terminal +/-

To connect battery series power cables

Battery Temperature Collection Port

Port for collecting the temperature of the battery cell in the battery box.

Battery Voltage Collection Port

The voltage and total voltage of each cell in the battery box are collected

CPU Download Port

Used to download or update CPU programs.

Fan Power Port

Battery box fan driver input port.

Battery Pack Communication Port

To connect battery series communication lines.

**Note:** Battery A module and battery B module are the only positive and negative extreme mouth is opposite.

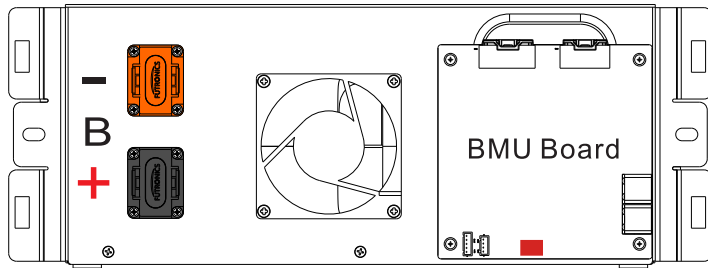

Figure-2 Battery B module panel appearance

### 3.2.2 Battery module dimension

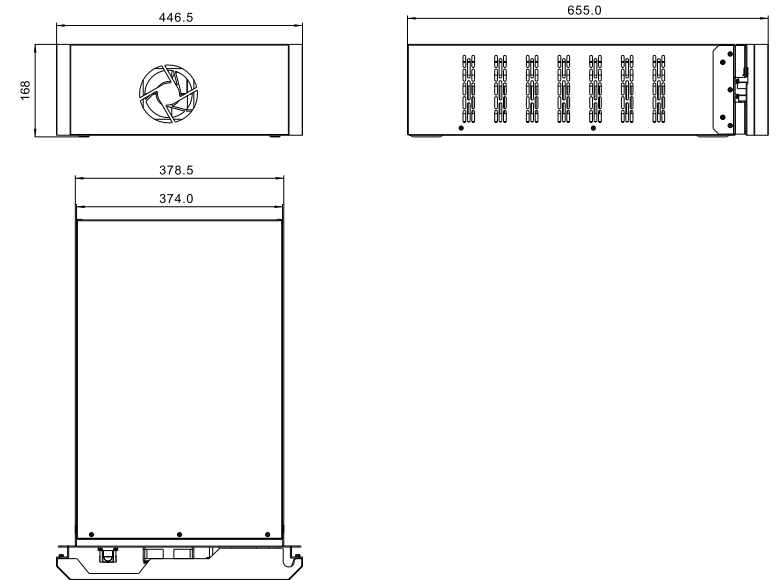

Figure-3 Battery module dimension

### 3.2.3 Battery module parameters

No.	Item	Parameters	Remark
1	Nominal voltage/capacity	51.2V/100Ah	16S
2	Weight	≤44Kg	Contains the accessories
3	Size	D655*W446.5*H168mm	Tolerance ±0.5mm
4	Insulation resistance	≥1000 Ω/V	2500V (DC)
5	Internal resistance	≤8m Ω	

Figure-4 Battery module parameters

### 3.2.4 Battery module standard configuration

Part name	Specification	Remarks																																							
ESS-BM-51.2-100R	Use lithium-iron phosphate battery, capacity 14.3KWh, including BMU,fuse.																																								
Power Terminal+/-	DC1500V/100A	M8/8N-M																																							
Power communication terminal	Ports CN5 and CN6 both serve as communication ports between batteries <table border="1" style="margin-left: 20px;"> <thead> <tr> <th>No.</th> <th>CN5</th> <th>CN6</th> </tr> </thead> <tbody> <tr><td>1</td><td>CAN_H</td><td>CAN_H</td></tr> <tr><td>2</td><td>CAN_L</td><td>CAN_L</td></tr> <tr><td>3</td><td>GND</td><td>GND</td></tr> <tr><td>4</td><td>+24V</td><td>+24V</td></tr> <tr><td>5</td><td>GND-A</td><td>GND-A</td></tr> <tr><td>6</td><td>+24V-A</td><td>+24V-A</td></tr> <tr><td>7</td><td>CANGND</td><td>CANGND</td></tr> <tr><td>8</td><td>NC</td><td>NC</td></tr> <tr><td>9</td><td>GND</td><td>GND</td></tr> <tr><td>10</td><td>+24V</td><td>+24V</td></tr> <tr><td>11</td><td>GND-A</td><td>GND-A</td></tr> <tr><td>12</td><td>+24V-A</td><td>+24V-A</td></tr> </tbody> </table>	No.	CN5	CN6	1	CAN_H	CAN_H	2	CAN_L	CAN_L	3	GND	GND	4	+24V	+24V	5	GND-A	GND-A	6	+24V-A	+24V-A	7	CANGND	CANGND	8	NC	NC	9	GND	GND	10	+24V	+24V	11	GND-A	GND-A	12	+24V-A	+24V-A	
No.	CN5	CN6																																							
1	CAN_H	CAN_H																																							
2	CAN_L	CAN_L																																							
3	GND	GND																																							
4	+24V	+24V																																							
5	GND-A	GND-A																																							
6	+24V-A	+24V-A																																							
7	CANGND	CANGND																																							
8	NC	NC																																							
9	GND	GND																																							
10	+24V	+24V																																							
11	GND-A	GND-A																																							
12	+24V-A	+24V-A																																							

#### Power Switch

Switch the battery system's (high voltage box and high voltage DC power)ON/OFF.

#### Power Terminal +/-

To connect battery series power cables(Battery cluster). Terminals marked BAT+ / BAT- are connected to the positive and negative terminals of the first battery pack and the last battery pack respectively.

#### Communication Port 1

To connect the first battery in series communication lines.

#### Communication Port 2/3

To connect high voltage box series communication lines.

#### Communication Port 4

Reserved debugging port.

#### External Power +/-

To connect HPS/PCS or DC Cabinet(When having three or more parallel systems).

#### USB Port

Used to upgrade the BCU board code.

#### Run/ Alarm Light

Indicates the normal running or cannot run properly of the system.

### 3.3.2 BPU dimensions

## 3.3 BPU

### 3.3.1 BPU front panel schematic

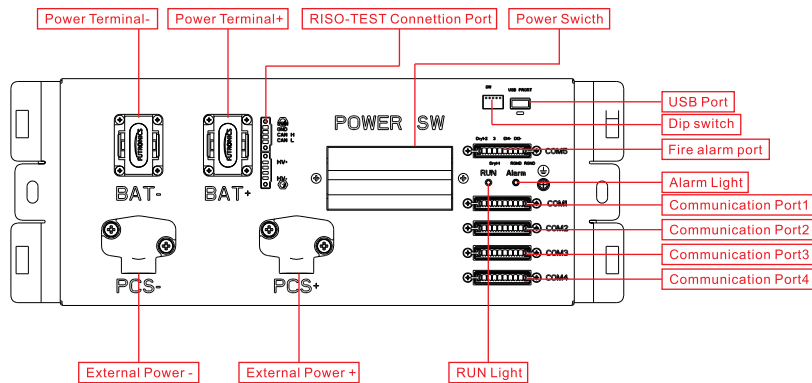

Figure-5 BPU front panel schematic

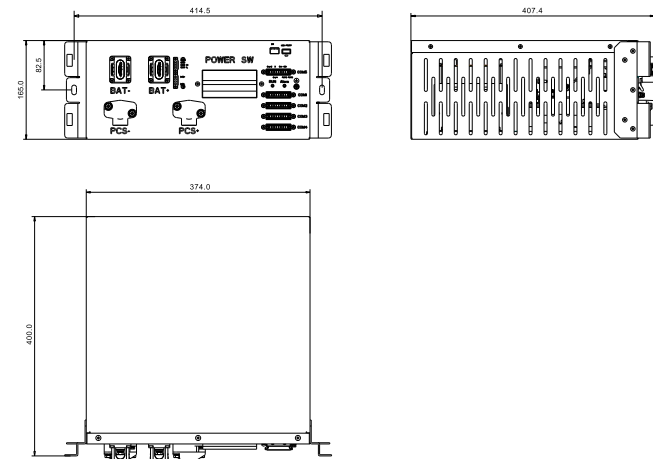

Figure-6 BPU dimensions

### 3.3.3 BPU standard configuration

Part name	specification	Remarks																																													
BPU body	It contains control board or three-layer motherboard, power board, power conversion module, fuse, relay, LED power indicator with red and green, and is made of insulated metal casing.																																														
Input/output terminal	DC1500V/100A	M10/16N·M																																													
Power communication terminal	Includes CAN, RS485, 24V power supply;																																														
	<table border="1"> <thead> <tr> <th>No.</th> <th>COM1</th> <th>COM2/COM3</th> <th>COM4</th> <th>COM5</th> </tr> </thead> <tbody> <tr> <td>1</td> <td>-24V</td> <td>-24V</td> <td>24V-</td> <td>Dry1-2</td> </tr> <tr> <td>2</td> <td>+24V</td> <td>+24V</td> <td>+24V</td> <td>Dry1-1</td> </tr> <tr> <td>3</td> <td>NC</td> <td>485_A</td> <td>RX_232</td> <td>NC</td> </tr> <tr> <td>4</td> <td>NC</td> <td>485_B</td> <td>TX_232</td> <td>NC</td> </tr> <tr> <td>5</td> <td>CAN1_H</td> <td>CAN2_H</td> <td>Relay4</td> <td>DI4-</td> </tr> <tr> <td>6</td> <td>CAN1_L</td> <td>CAN2_L</td> <td>Relay5</td> <td>RGND</td> </tr> <tr> <td>7</td> <td>CANGND</td> <td>EX485_A</td> <td>Relay6</td> <td>DI3-</td> </tr> <tr> <td>8</td> <td>NC</td> <td>EX485_B</td> <td>EGND</td> <td>RGND</td> </tr> </tbody> </table>	No.	COM1	COM2/COM3	COM4	COM5	1	-24V	-24V	24V-	Dry1-2	2	+24V	+24V	+24V	Dry1-1	3	NC	485_A	RX_232	NC	4	NC	485_B	TX_232	NC	5	CAN1_H	CAN2_H	Relay4	DI4-	6	CAN1_L	CAN2_L	Relay5	RGND	7	CANGND	EX485_A	Relay6	DI3-	8	NC	EX485_B	EGND	RGND	
No.	COM1	COM2/COM3	COM4	COM5																																											
1	-24V	-24V	24V-	Dry1-2																																											
2	+24V	+24V	+24V	Dry1-1																																											
3	NC	485_A	RX_232	NC																																											
4	NC	485_B	TX_232	NC																																											
5	CAN1_H	CAN2_H	Relay4	DI4-																																											
6	CAN1_L	CAN2_L	Relay5	RGND																																											
7	CANGND	EX485_A	Relay6	DI3-																																											
8	NC	EX485_B	EGND	RGND																																											

### 3.4.2 Battery cabinet detailed layout

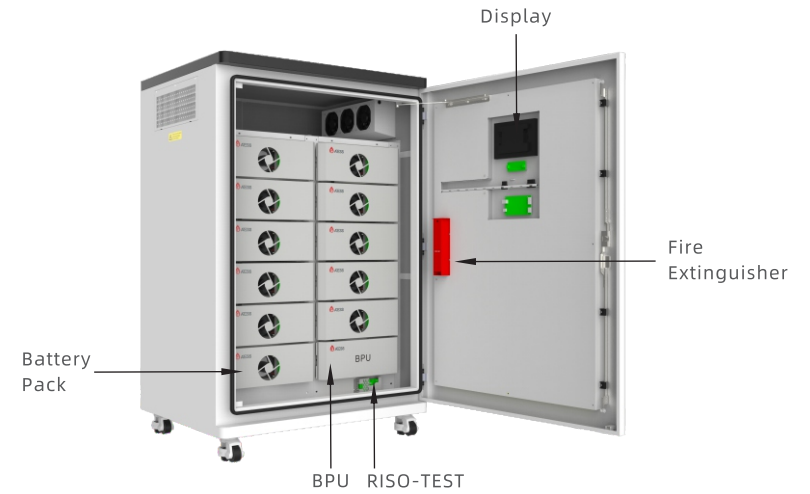

Figure-8 Battery cabinet detailed layout

## 3.4 Battery cabinet

### 3.4.1 Battery cabinet dimensions

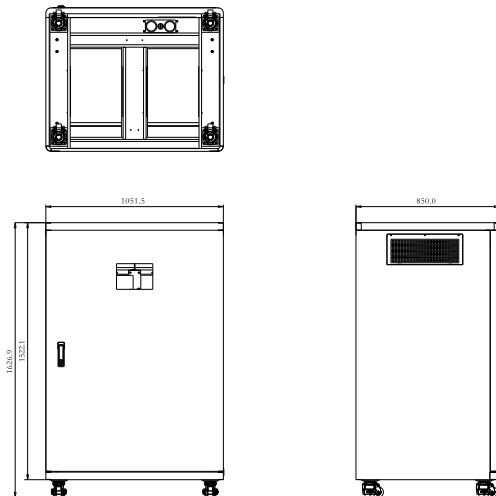

Figure-7.1 Battery cabinet size

### 3.4.3 Battery cabinet configuration

The main components of the BC series energy storage battery cabinet system are shown in Table-1 below.

No.	Materials	Type	BC55RPB*N	Unit
1	Product inspection report		1	PCS
2	Product certification		1	PCS
3	Battery Pack-A		5*N	PCS
4	Battery Pack -B		6*N	PCS
5	High voltage box		1*N	PCS
6	Battery Pack series DC cable 1		1*N	PCS
7	Battery Pack series DC cable 2		1*N	PCS

## Operating Environment 4

No.	Materials	Type	BC55RPB*N	Unit
8	Battery Pack series DC copper bar		9*N	PCS
9	BPU to battery negative copper bar		1*N	PCS
10	Battery communication line		9*N	PCS
11	BPU to battery communication line		1*N	PCS
12	BPU to display communication line		1	PCS
13	Display to inverter communication line		1	PCS
14	Battery rack		1*N	PCS
15	M6*20 hex head combination screw		24*N	PCS

Table-1 Main components of BC battery energy storage system

**Note:** In the table 2, N indicates the number of parallel battery systems. For example, N=2 indicates a two-parallel battery systems, it's made up of two BR50R. Some materials need to be multiplied by 2.

Battery operating environment requirements are as follows

Working temperature: 0 °C - 45 °C

Relative humidity: 5% - 95%, no condensation

Altitude: ≤2000m

On-site environment: keep away from heat sources, avoid direct sunlight, no corrosive gas, no explosive gas, no gas that destroys insulation, Conductive dust without damaging insulation.

# 5 Transportation and storage requirements

## 5.1 Transportation and storage

The battery module and cabinets should be transported separately. Pay attention to the identification on the packing box when transporting and storing the product. The storage location should be:

- No corrosive gas around
- No excessive humidity and high temperature source
- Non-dusty environment
- Meet fire protection requirements
- Short-term storage (one month), it is recommended that the storage temperature was 20° C~45° C
- Long-term storage (1 year), it is suggested that is stored in the environment temperature 0° C~35° C, clean, dry and ventilated indoor environment. Avoid contact with corrosive materials and stay away from fire and heat sources.
- Environmental humidity<70%

### During transportation, handling and installation:

- Avoid collision of parts or parts with objects such as doors, walls, and shelves.
- Wearing neat gloves, it is strictly forbidden to touch parts with bare hands, sweaty or dirty gloves.

## 5.2 Transporting

User can lift the whole package box from the bottom by means of a forklift and can transport it independently, as shown in figure-9.



Figure-9 Forklift use reference diagram



# 6 Device installation and configuration

## 6.1 Installation preparation

### 6.1.1 Safety regulations

Only those who have received training in the power system and have a good knowledge of the power system are allowed to install the device. Always follow local safety regulations and the safety requirements listed below during installation.

Before installing or removing the device, make sure that the power system is not powered and that the battery device is turned off. Distribution cable routing should be reasonable and protective, to avoid touching these cables when operating the power supply.

### 6.1.2 Check the operating environment

The operating environment shall comply with the requirements described in Chapter 4, "Operating Environment" . If it does not, it shall be rectified and the operating environment shall be re-examined.

## 6.2 Tool Preparation















No.	Name	Quantity	Model	Remark	Legend
1	Wrench	4	12-inch	Plastic handle (with scale)	
2	Warning band	10	Rubber road cone 70CM reflective	High 70CM bottom 44x44CM	
3	Herringbone ladder (1.9m)	2	Wide pedal herringbone ladder 1.9m		
4	Helmet	6	3M	Glass reinforced plastics conventional red	
5	Gloves (DC insulation)	4	Thickened anti-electric		
6	Insulated shoes	6	3M		
7	Multimeter	2	1kV range		
8	Clamp ammeter	2	2kA range		
9	Elevator	1	Lifting height of 2.2M or more		
10	Sleeve	2	Interchangeable		
11	Tape measure	1	100M		

Table-2 Installation tool table

No.	Name	Quantity	Model	Remark	Legend
12	Forklift	2	Interchangeable		
13	Electric drill	2	Interchangeable		
14	Insulation resistance meter	1	Interchangeable		

## 6.3 Unpacking inspection

Before the battery module is ready for installation, an unpacking check is required, mainly check the following:

- Check whether the number of items in the packing list matches the actual items
- Check whether the documents and accessories are complete
- Check whether the battery module case is deformed, painted or loose

Take photos before and after unpack the packing. If the number of items is the same as the packing list, sign the confirmation packing list with the customer. If find the equipment is damaged or corroded during the unpacking inspection process, it should be promptly reported

## 6.4 Preparation before installation

- Make sure all the BPU switches are in the OFF state
- Cut off all relevant equipment power supply

## 6.5 Battery module installation

Before install the battery module check that the battery cabinet is properly installed and grounded.

1). ake the battery module out of the box.

2). The installation position of the battery box is determined according to the position of the high voltage box.As shown in the figure-10, battery pack A is in the same column as the high voltage box, and battery pack B is in the remaining column.

3). The address of the battery box is set according to the dial switch (CN7) on the BMU board, as shown in Figure-11 , the dial switch is set according to the binary address, from 1 to 5 switch represents high to low, for example: only open the first switch, close 2 to 5 switch, the set address is 16.



Figure-10 Installation position diagram of the battery and the BPU (picture is for reference only)

4) Place the battery case in the corresponding position of the battery holder according to Figure-12, and fix the battery case to the battery holder with the matching M6 screw.

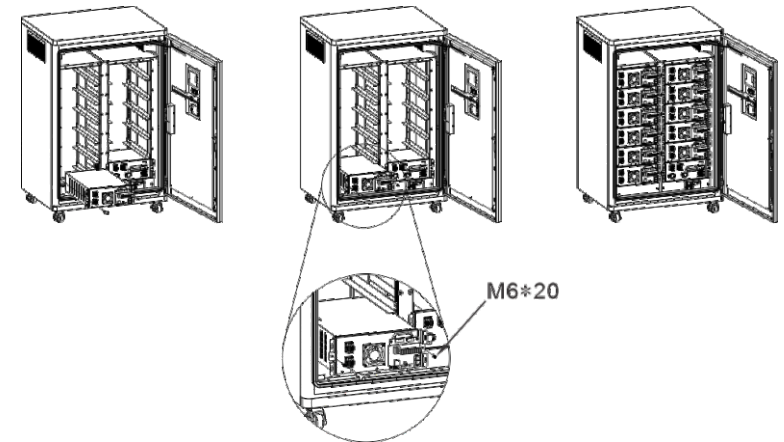

Figure-12 Installation diagram of the battery module (picture is for reference only)

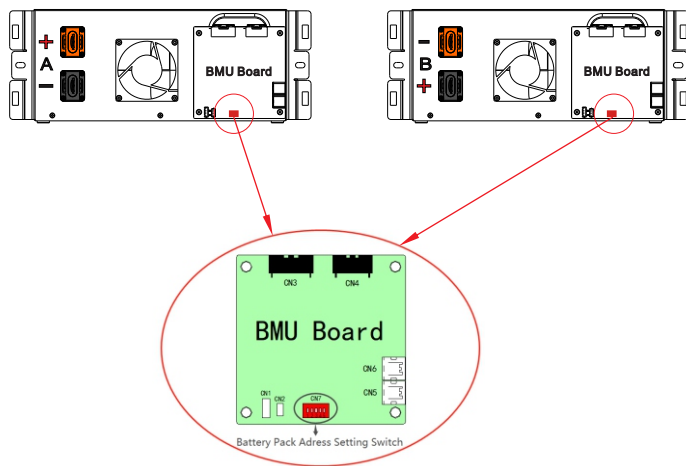

Figure-11 Diagram of battery pack and BMU board

### Precautions:

Wear protective shoes when assembling energy storage systems

- Staff long-sleeved shirt. It is forbidden to wear sleeveless shirts and it is forbidden to roll up the sleeves
- All personnel involved in the work wear appropriate gloves
- The battery module is about 115kg depending on the model. It is forbidden to move by one person to prevent personal injury
- Each battery cluster is 2 columns, 6 layers. After installation, check the installation order and position of each cluster of battery modules. It is forbidden to mix different clusters of battery modules
- The torque of the battery module locking bolt is 12Nm

## 6.6 Electrical connections

### 6.6.1 Connecting ground

Grounding resistance needs to be less than  $1\Omega$ ;

### 6.6.2 Battery module DC cable/copper bar

1). Take out the matching series DC cable/copper bar as shown in Figure-13 and separate the series DC cables according to the cable labels.

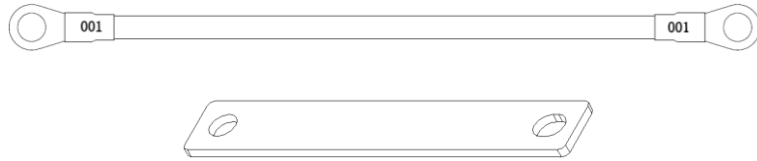

Figure-13 Schematic diagram of the series DC cable/copper bar (picture is for reference only)

2). According to the wiring position of Figure-14, connect the No. 3 series DC copper bar to each cluster first, then connect the No. 1 serial DC cable, then connect the No. 4 serial DC copper bar, and finally connect the No. 2 cable.

3). Connect from bottom to top during wiring to prevent misconnection and shorting.

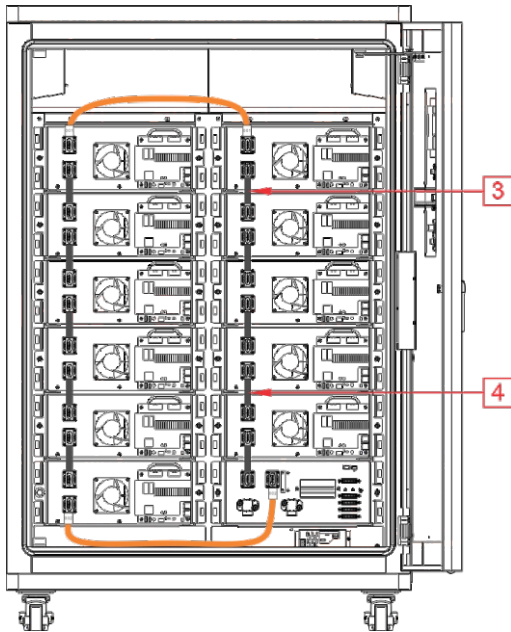

Figure-14 Battery cluster DC cable wiring diagram (picture is for reference only)

NO.	Name	length(mm)	Quantity
1	Series DC cable 1	570	1
2	Series DC cable 2	980	1
3	Battery Serial copper bar	135	9
4	BPU to batteries negative copper bar	135	1

Series DC Cable

### Demonstration of installation examples :

- Each battery cluster is 2 columns, 6 layers. When connecting DC cables, connect the battery module of each column in series, and measure the voltage of each column of the battery module with a multimeter. If there is no abnormality, then string the two columns of battery modules.
- After all the batteries in the cluster are connected in series, use the insulation meter to measure the insulation level between the positive electrode of the battery cluster (the positive electrode of the battery module 1) and the battery cabinet, and the insulation level between the negative electrode of the battery cluster (the negative electrode of the battery module 11) and the battery cabinet. The insulation should be more than  $100\Omega/V$ .
- After the DC cable is connected, tap the cable plug connector with a rubber hammer to ensure that the cable is securely installed.

### 6.6.3 Battery module communication cable wiring

1) Take out the matching battery module communication line as shown in Figure-15 and separate the communication line according to the battery module communication line label.



Figure-15 Battery module communication cable diagram (picture is for reference only)

2) According to the wiring position shown in Figure-16, each cluster is connected to the battery module communication line in the S-shape from the lower right corner.

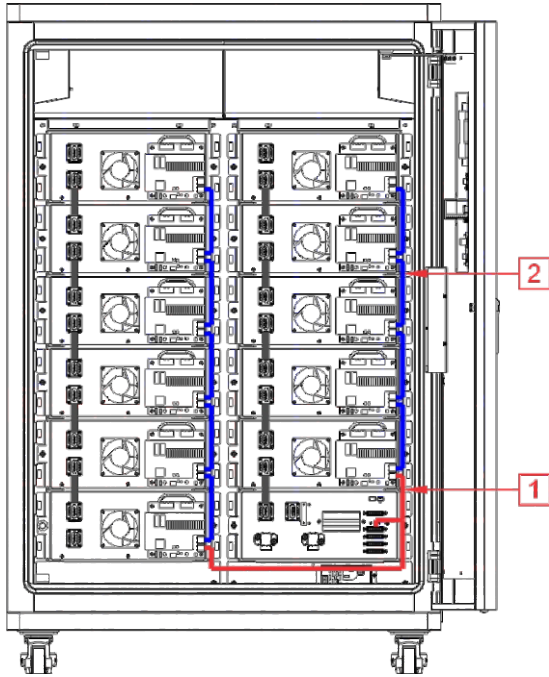

Figure-16 Battery cluster communication cable wiring diagram  
(picture is for reference only)

NO.	Name	Length(mm)	Quantity
1	BPU to battery pack communication line	850	1
2	Batteies series communication line	195	9

Battery pack communication line

#### 6.6.4 BPU wiring instructions

After the power line and communication line inside the battery cabinet are connected, install the inverter according to the inverter manual, and connect the battery input end of the inverter to the DC output end of the battery BPU, and output the BPU COM2. The line is connected to the CAN communication input port of the inverter.

**Note:**When three units are paralleling (include three), COM 2 port of BPU-1 connect to DC cabinet, one unit or two units are paralleling, COM 2 port of BPU-1 connect to display.

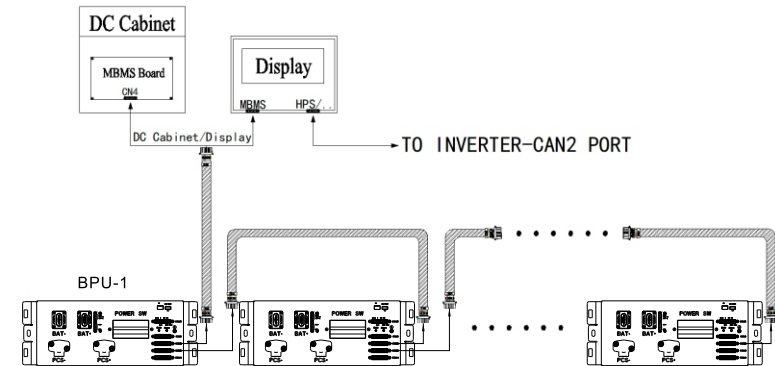

Figure-17 Schematic diagram of the BPU wiring for reference

### 6.7 Post-installation check

After the installation of the energy storage system is completed, post-installation inspection is required:

- The battery cabinet and the battery module are aligned with the mounting holes, the screws are tightened, and the torque meets the requirements (12Nm)
- The battery module number and installation location are the same

#### Precautions:

- Check whether each communication cable interface is secure and the single small wire harness is loose before installation
- Check the screws of each interface after installation to confirm whether it is tightened

## 6.8 Power on

### 6.8.1 System power supply instructions

Inside the container system, the power supply mode of the system is always determined by the total voltage of the battery module, regardless of the standalone or parallel system

### 6.8.2 System power-on instructions

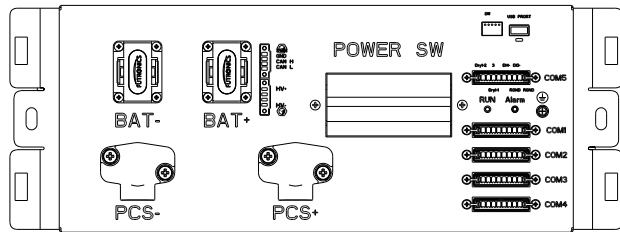

Figure-18 BPU front interface

- 1) Before powering on, please check whether the battery power line and communication line are consistent with the instructions in the installation manual.
- 2) After confirming that there is no problem with the wiring, you can first dial the POWER SW, close the DC power switch, and the system is powered on.

## 6.9 Function operation and testing

No.	Status	Description
1	Mode green light: 3s flashing cycle - slow flashing	System standby
	Alarm red light: often off	Trouble free
2	Mode green light: 1s flashing cycle	charging
	Alarm red light: 1s flashing cycle	First level alarm
3	Mode green light: 2s consecutive flashes	Discharge state
	Alarm red light: 2s consecutive flashes	Secondary fault
4	Mode green light: always BCight	system error
	Alarm red light: 3s flashes in succession	Tertiary fault

BPU LED indicator description

**Special note:** When wiring the COM port of the BPU, please pay attention to the line mark on the connection line, beware of incorrect wiring

– End of installation –







# 7 Maintenance

## 7.1 Safety instructions for inspection and maintenance

- 1) There is potential danger in the battery, so proper protective measures must be taken during operation and maintenance.
- 2) The battery must be operated with the correct tools and protective equipment.
- 3) Battery maintenance must be carried out by people with battery expertise and safety training.
- 4) The operator may be injured by chemicals, electric shock or electric arc during operation. Although each human body's response to DC and AC current is different, DC or AC current with voltage higher than 50V are equally serious to human body, so the operator must take a conservative posture in operation to avoid the current injury.
- 5) When operating batteries and selecting personal protective equipment, customers and their employees must take the above risks into account to prevent accidental short circuit, arc, explosion or thermal runaway.
- 6) In case of any abnormal problems, please contact the after-sales technical personnel in time.
- 7) If you need to open the cover for maintenance (such as forced charge and discharge of cell, replace board, etc.), please carry out with the authorization of our engineer.

## 7.2 Tools to be used during maintenance

Prepare tools to be used during maintenance before operation.

	Cell phone that can take photos
	Multimeter
	Thermometer
	Pen and paper
	Spanner, screwdriver etc
	Thermal imager

## 7.3 System inspection table

When carrying out inspection, maintenance and inspection work, it is necessary to conduct inspection one by one according to the table, and describe the corresponding problems of the faulty items.

Please refer to Appenx -System inspection and Maintenance Checklist in Capture 9.

## 7.4 system inspection and maintenance record

### 7.4.1 Main page parameters and fault parameter records

Date	Serial number	Location	Station name	Status
Vtotal	Location Vmax	Cell Vmax	Location Vmin	Cell Vmin
Itotal	Location Tmax	Cell Tmax	Location Tmin	Cell Tmin
SOC	Cell Vdiff ΔU	Cell Tdiff ΔT		

At the same time of data recording, it is also necessary to take photos of the actual situation for retention. The interface photos are as follow:





7.4.2 The following three tables are battery standby, charging and discharging. You can select one of them to record according to the actual situation during the inspection.

(1) Observe the minimum and maximum values of the battery voltage, and record the module position in the battery cabinet standby state:

	Cell voltage	Module No.	Battery cabinet No.	Serial No. of battery cluster
Max. cell voltage				
Min. cell voltage				

(2) Observe the minimum and maximum values of battery voltage, and record the module position when charging. The charging power is 100% of the rated capacity of the inverter (if the HPS is 5kW, the charging power is set to 5kW), please ensure that the HPS can be charged through a constant current.

	Cell voltage	Module No.	Battery cabinet No.	Serial No. of battery cluster
Max. cell voltage				
Min. cell voltage				

(3) Observe the minimum and maximum values of the battery, and record the module position when discharging. The discharge power is 100% of the rated capacity of the inverter (if the HPS is 5kW, the discharge power is set to 5kW), please ensure that the HPS can discharge through a constant current.

	Cell voltage	Module No.	Battery cabinet No.	Serial No. of battery cluster
Max. cell voltage				
Min. cell voltage				

Note:

1. It is recommended to run the charge / discharge test at a constant current for at least 3-5 minutes, and then record on paper.
2. "Field test battery" is the most important debugging procedure.
3. If the battery voltage is found to be too high or too low, the battery needs to be charged or discharged under the guidance of the ATESS engineer.
4. If the temperature is abnormal, the temperature sensor needs to be replaced under the guidance of ATESS engineer.
5. If there is no available power supply to charge the battery for more than 2 weeks, it is recommended to charge the battery forcibly.

## 7.5 Liability exemption

ATESS does not provide quality warranty services for:

1. Damage caused by improper use, maintenance or inspection of products that not in accordance with the provisions of this manual.
2. Damage caused by false installation of the manual maintenance switch(CB/ MCB).

3. Damage caused by using charging equipment that does not meet the standard or improper charging operation.

4. Parts not produced by ATESS, such as high-voltage harness, etc.5. The battery system is soaked or drown by water.

6. Damage caused by refitting, adding or disassembling battery system without permission of after-sales department or authorized service provider of ATESS.

7. Damage caused by the operation failure when battery is defective without the permission of ATESS after-sales department.

8. Damage caused by force majeure, such as earthquake, typhoon, flood, chemical pollution, lightning strike, hail, sediment, flying stone, fire, or considered intentional damage etc.

# Common Troubleshooting 8

## 8.1 Fault and abnormal state processing

### Appendix A

#### FAQ

Q. After closing the POWER SW switch, the battery system has no output.

A. Observe the status of the battery module and the BPU LED lamp;

1) If some of the cabinets are not lit, it is necessary to confirm whether the cabinet with the last LED light is connected to the next cabinet without the LED light and the communication line connected to all the cabinets without the LEDs is incorrect. Or missing the connection, or even the communication line is damaged;

2) If all the cabinets are not lit, it indicates that there is a problem with the power supply of the system. It is necessary to check whether the power line of the cabinet system is incorrectly wired or missing. If there is no error in the power wiring, then the BPU needs to be opened to check whether the power circuit is faulty.

3) If all the cabinet LED lights are on, you need to check the fault according to the battery module and the BPU indicator.

Q. What should I do if the indicator light of the BPU shows the first level alarm, the second level protection, and the third level protection?

A, 1) Level 1 alarm: The system is running normally without any action;

2) Two-level fault: the battery system has no action and the inverter is standby;

3) Three-level fault: The battery system cuts off the main circuit relay. Inverter shutdown

4) If there is a system failure, you can first view the fault type information on the operation data page on the inverter display, if the fault type information is viewed on the display of the battery system.

## 8.2 Annex B

The system has the following second and third level fault information description.

Fault level	Fault description	Remarks
<b>Secondary Fault</b>	High secondary charging temperature	Adjustable
	High secondary discharge temperature	Adjustable
	Low secondary charging temperature	Adjustable
	Low secondary discharge temperature	Adjustable
	Large temperature difference between the two cells	Adjustable
	High secondary total voltage	To be determined
	Low secondary total voltage	To be determined
	Large total voltage difference between the two stages	To be determined
	High secondary cell voltage	Adjustable
	Low secondary cell voltage	Adjustable
	Large voltage difference between the two cells	Adjustable
	Large secondary charge current	Adjustable
	Large secondary discharge current	Adjustable

Fault level	Fault description	Remarks
<b>Tertiary fault</b>	Three-level charging temperature is high	Adjustable
	Three-level discharge temperature is high	Adjustable
	High temperature protection recovery value	Adjustable
	Three-level charging temperature is low	Adjustable
	Three-level discharge temperature is low	Adjustable
	Low temperature protection recovery value	Adjustable
	Three-level of temperature difference	Adjustable
	High three-level total voltage	To be determined
	Low three-level total voltage	To be determined
	Three-level total voltage difference	To be determined
	High level three-level voltage	Adjustable
	Low level three-level voltage	Adjustable
	Three-level charging current is large	Adjustable
	Three-level discharge current is large	Adjustable
	Tertiary fault	Adjustable



# 9 Annex

## System inspection and Maintenance Checklist

No.	Category	Check item	Check method	Standard	Result	Problem description	Check frequency
1	Circuit BCeaker maintenance	Whether circuit BCeaker(CB) of DC cabinet in parallel system trips	Visual inspection	CB all connected	<input type="checkbox"/> Normal <input type="checkbox"/> Abnormal		Once two weeks
2		Whether DC Micro BCeaker(MCB) of BPU trips	Visual inspection	MCB all connected	<input type="checkbox"/> Normal <input type="checkbox"/> Abnormal		
3	Software diagnostics	Software version	BMS data reading or screen	Record the software version	<input type="checkbox"/> Normal <input type="checkbox"/> Abnormal		Once two weeks
4		System alarm	BMS data reading or screen	No alarm in the alarm bar	<input type="checkbox"/> Normal <input type="checkbox"/> Abnormal		
5		Battery consistency	BMS data reading or screen	The static differential pressure shall be within 20mV	<input type="checkbox"/> Normal <input type="checkbox"/> Abnormal		
6	System operation status and environment	Whether the indoor or container ambient temperature is 20° C~ 40 ° C, and whether the temperature control equipment is in good condition	Thermometer	20° C~30° C	<input type="checkbox"/> Normal <input type="checkbox"/> Abnormal		Once two weeks
7		Whether the temperature of battery module is normal, and whether the maximum temperature difference between modules is less than 5° C	BMS data reading or screen	<5° C	<input type="checkbox"/> Normal <input type="checkbox"/> Abnormal		
8		Whether the voltage of each cell in the system is normal, and whether the maximum voltage difference between each battery is less than 100mV	BMS data reading or screen	<100mV	<input type="checkbox"/> Normal <input type="checkbox"/> Abnormal		

No.	Category	Check item	Check method	Standard	Result	Problem description	Check frequency
9		Check the fault page of the display and check whether the battery system reports abnormal information	BMS data reading or screen	No fault record	<input type="checkbox"/> Normal <input type="checkbox"/> Abnormal		Once two weeks
10		Status of the air condition in container	Visual inspection, thermometer	25±3° C	<input type="checkbox"/> Normal <input type="checkbox"/> Abnormal		
11	System cleaning	Whether the battery module and battery cabinet have abnormal sound or smell	Smell	No abnormal sound or smell	<input type="checkbox"/> Normal <input type="checkbox"/> Abnormal		Once two weeks
12		Is there water leakage or other foreign matter in the room or container	Visual inspection	No water leakage or foreign matters	<input type="checkbox"/> Normal <input type="checkbox"/> Abnormal		
13		Whether there are rodents and insects such as mice, geckos, cockroaches and ants in the room	Visual inspection	No animals or insects	<input type="checkbox"/> Normal <input type="checkbox"/> Abnormal		Once two weeks
14		DC cable connection between battery boxes	Visual inspection /thermometer	No obvious heating or temperature below 70 ° C	<input type="checkbox"/> Normal <input type="checkbox"/> Abnormal		
15	Circuit connection	Communication connection between battery boxes	Visual inspection /BMS fault record	No CAN communication fault	<input type="checkbox"/> Normal <input type="checkbox"/> Abnormal		Once two weeks
16		External power supply input connection of high voltage box	Visual inspection, recommended to take pictures	AC circuit BCeaker remains closed	<input type="checkbox"/> Normal <input type="checkbox"/> Abnormal		
17		Battery cabinet ground connection	Visual inspection, multimeter	<=4Ω	<input type="checkbox"/> Normal <input type="checkbox"/> Abnormal		

No.	Category	Check item	Check method	Standard	Result	Problem description	Check frequency
18	Circuit Breaker maintenance	Check whether the power cable plug is loose or not tightened, and whether the power cord surface is damaged	Visual inspection	No damage	<input type="checkbox"/> Normal <input type="checkbox"/> Abnormal		Once two weeks
19		Check whether the plug of communication cable is loose or not tightened, and whether the surface of communication cable is Broken	Visual inspection	No loose or fracture	<input type="checkbox"/> Normal <input type="checkbox"/> Abnormal		
20		Check the fan blades for cabinets	Visual inspection	No cabinet on blade	<input type="checkbox"/> Normal <input type="checkbox"/> Abnormal		
21	Fan maintenance and replacement	Listen to whether there is abnormal vibration sound when the fan is running	Hear, spanner, screwdriver, etc	No abnormal sound	<input type="checkbox"/> Normal <input type="checkbox"/> Abnormal		Once two weeks
22		If the fan has any abnormal condition, it shall be replaced in time	Visual inspection	No abnormality	<input type="checkbox"/> Normal <input type="checkbox"/> Abnormal		
23		Is the indoor or container lighting system in good condition	Visual inspection	Normal lighting	<input type="checkbox"/> Normal <input type="checkbox"/> Abnormal		
24	System operation status and environment	Is there any fault in the DC cabinet or BPU in the parallel system or the red light flashes	Visual inspection	No red light flashing in fault record	<input type="checkbox"/> Normal <input type="checkbox"/> Abnormal		Once two weeks
25		Fire fighting facilities in good condition	Visual inspection	Fire fighting facilities not expired	<input type="checkbox"/> Normal <input type="checkbox"/> Abnormal		