

**SHENZHEN ATESS POWER TECHNOLOGY CO.,LTD**

GROWATT-ATESS Industrial Park, No.23 Zhulongtian Road, Shuitian Community,  
Shiyan Street, Baoan District, Shenzhen

Tel: +86 755 2998 8492

Web: [www.atesspower.com](http://www.atesspower.com)

Email: [info@atesspower.com](mailto:info@atesspower.com)

Revised date: 2026-06-09

**HPS50000TL-US-208A**

Hybrid Energy System  
User Manual

# Contents

## 1 About this Manual

- 1.1 Contents
- 1.2 Symbols explanation

## 2 Safety Instructions

- 2.1 Correct installation
- 2.2 Operator
- 2.3 Inspection and storage
- 2.4 Transportation
- 2.5 Installation
- 2.6 Repair and maintenance
- 2.7 Inverter EMC and noise level
- 2.8 Important note

## 3 Product Description

- 3.1 Energy Storage system
- 3.2 Circuit diagram of the inverter
- 3.3 Product specification
- 3.4 The layout of the main parts
- 3.5 Working mode
- 3.6 Battery setting
- 3.7 Storage
- 3.8 Packaging information

## 4 Products Installation

- 4.1 Installation Condition Requirements
- 4.2 Installation environment
- 4.3 Space requirement
- 4.4 Tools for installation
- 4.5 Mechanical installation
- 4.6 Electrical installation
- 4.7 Communication
- 4.8 Installation inspection

## 5 Commissioning

- 5.1 Relevant requirements
- 5.2 Inspection
- 5.3 Power on steps
- 5.4 Pilot operation completion
- 5.5 Power off steps

## 6 HMI

- 6.1 Introduction to touch screen
- 6.2 Touch screen operation
- 6.3 LCD display information schedule

## 7 Routine Maintenance

- 7.1 Fan maintenance
- 7.2 Regular maintenance
- 7.3 Waste treatment

## 8 Appendix

- 8.1 Specification
- 8.2 Warranty

# 1 About this Manual

This chapter describes the overview of this manual and safety symbols, can help users to have a better understanding of the manual.

## 1.1 Contents

This manual applies to ATESS HPS50000TL-US-208A hybrid energy system, the manual contains:

### Safety instruction

Attention that needs to be paid when operating and maintaining ATESS HPS50000TL-US-208A

### Product description

The role inverter plays in the energy storage system and structure, principle, protection, operation mode, storage and package size of the ATESS HPS50000TL-US-208A.

### Product Installation

Inverter installation conditions, tools, and the inverter mechanical and electrical installation, the communication connection and inspection.

### Commissioning

Inspection before commissioning and procedure to turn on/off inverter.

### HMI

Information displayed on the inverter LCD touch-screen and setting instruction.

### Routine maintenance







Daily maintenance of the inverter, the replacement of some spare parts and waste disposal instruction.

### Appendix

Technical data, warranty policy and contact information./

## 1.2. Symbols explanation

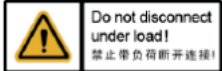
In order to ensure the personal and property safety of the user during installation, or optimally efficient use of this product, symbols are used highlight the information. The following symbols may be used in this manual, please read carefully, in order to make better use of this manual.

Symbol	Symbol name	Implication
	Risk of electric shock	This inverter contains high voltage during operation. All relative operations must be proceeded by the professional electricians.
	Delay discharge	There will be residual voltage in the inverter, it takes 5 mins to completely discharge.
	Overheated	It's forbidden to touch the shell of inverter during running due to overheating.
	Refer to user manual	A reminder for the operator to check the user manual that goes with the inverter.
	PE terminal	Connect the inverter with PE terminal for earthing protection
	Operation warning	Do not disconnect the DC input directly when the inverter is running
	CE certified	This product is complied with CE certification standard.

## 2 Safety Instructions

Inverter installer and service personnel must be trained and familiar with the general safety requirement when working on electrical equipment. Installer and service personnel should also be familiar with the local laws and regulations and safety requirements.

- Read this manual carefully before operation. The equipment will not be under warranty if failing to operate according to this manual.
- Operation on the inverter must be for qualified electrical technician only.
- When inverter operating, don't touch any electrical parts except for the touchscreen.
- All electrical operation must comply with local electrical operation standards.
- Warranty service for the inverter does not contain module maintenance.
- Permission from the local utility company is required before installing the Energy Storage system and only professional personnel are qualified for the operation.

### 2.1 Correct installation

Proper installation requires following all the instructions in the user manual involving transportation, mounting, wiring and commissioning. ATESS does not cover warranty for the inverter damage due to improper use.

- Note the instruction in this chapter and after
- Follow the manual
- Refer to relevant data and technical spec

**IMPORTANT SAFETY INSTRUCTION & SAVE THESE INSTRUCTIONS**

### 2.2 Operator

Inverter installer and service personnel must be trained and familiar with the general safety requirement when working on electrical equipment. Installer and service personnel should also be familiar with the local laws and regulations and safety requirements.



**WARNING:**

This unit is not provided with a GFDI device. This inverter or charge controller must be used with an external GFDI device as required by the Article 690 of the National

### 2.3 Inspection and storage

The inverter should be carefully check before signing the document from the transportation company. Check the received items against delivery note, and if there is any defect or damage, immediately notify the transportation company. If necessary, you can seek help from ATESS Customer Service Department.



**Note:**

ATESS HPS50000TL-US-208A can be stored in a dry room to protect the internal circuits against dust and moisture.

### 2.4 Transportation

Transportation should follow the transportation methods described in the user manual. The inverter's weight and center of gravity should be taken into account during transportation. The center of gravity is marked on the box.



**Caution, risk of danger**

During the process of moving and lifting the inverter, the operator must be qualified. The inverter should be placed vertically and the inclination cannot be more than 10 degrees. It is not allowed to place the inverter upside down or transport in a horizontal position. Incorrect lifting and transportation can lead to serious injury, property loss and damage to the inverter.

## 2.5 Installation

Hybrid inverter is with IP65/Type3R protection level and designed for wall-mounting installation. Installation of the inverter must be according to information included in this manual especially on Chapter 4.

## 2.6 Repair and maintenance



Repair and maintenance can only be carried out after disconnecting the DC and AC breakers for at least 5 minutes. Only professional technical personnel are qualified for the operation.

### Disconnect breaker

Getting PV and BAT switch to disconnect inverter from battery and solar array, and Getting GRID input switch to disconnect inverter from grid. Make sure inverter cannot be connected with power source. Test with multi-meter and make sure all switch and breaker without voltage potential. Even inverter is disconnected from grid and battery, PV, some component inside inverter such as capacitor is still with energy stored and is dangers when capacitor discharge, so at least 20 minutes later check with multi-meter that BUS line is without voltage potential, then operate accordingly.

### Maintenance and modification

Only personnel with ATESS authorization are qualified for the maintenance and modification. And to ensure personal safety, use original accessories provided by the manufacturer only. Otherwise, electrical safety and EMC might not comply with the required standard.

### Function and safety parameters

Don't change the parameters of the inverter without authorization from the local utility and ATESS Energy Technology Co., Ltd. Otherwise, it might lead to injury or equipment damage and the warranty of the inverter will be invalid.

## 2.7 Inverter EMC and noise level

Electromagnetic compatibility (EMC) is the requirement for electrical equipment that it can operate normally in the electromagnetic environment and does not cause unacceptable environmental impact itself. So EMC represents the quality characteristics of electrical equipment:

Hybrid inverter can generate certain noise and electro-magnetic radiation, according to EMC and noise level, the inverter is qualified for installation and operation in industrial environment.

## 2.8 Important note

### Information

Note 1: Static electricity can cause damage to the inverter

Electrostatic discharge may cause unrecoverable damage to inverter internal components! When operating the inverter, operator must comply with anti-static protection regulations!

Note 2: Restriction

The inverter cannot be directly used to connect the life support equipment and medical equipment!

Item 3: Precautions

Make sure installation tools or other unnecessary items are not left inside the inverter before starting up.

Item 4: Maintenance notice

Maintenance can only be carried out after the inverter totally discharged.



# 3 Product Description

## 3.1 Energy Storage system

ATESS HPS50000TL-US-208A hybrid inverter is designed for energy storage system, it converts DC current generated by battery bank into AC current and feed into the load/grid, also it can take power from solar or grid to charge battery .

## 3.2 Circuit diagram of the inverter

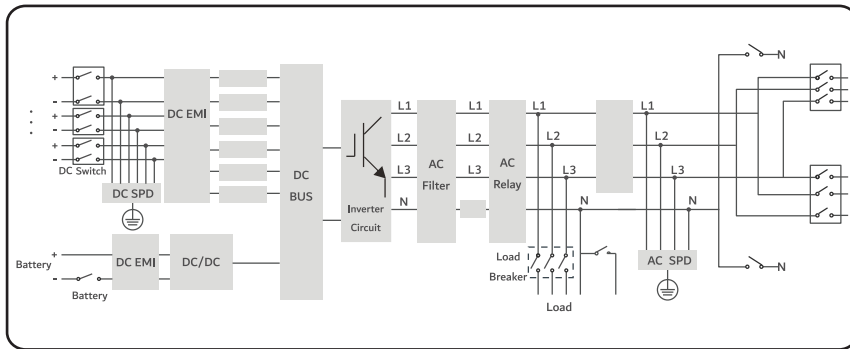

Figure 3-2-1 ATESS HPS50000TL-US-208A circuit diagram

## 3.3 Product specification

### 3.3.1 Input parameter

Inverter model	HPS50000TL-US-208A
Max. PV power	75kW
Max. PV open-circuit voltage	650V
PV MPPT voltage range	125V-550V
Bat input voltage range	260V-620V
Bat Max.charge/discharge current	100A

### 3.3.2 Output parameter

Energy storage controller model	HPS50000TL-US-208A
Rated AC output power	50kW
Rated AC output current	138.7A
Rated AC output frequency	50/60HZ
Rated AC voltage	120/208V
Power factor	0.8lagging-0.8leading

### 3.3.3 Important notes

#### Note1: Usage restrictions



- A. If the load connected to the inverter is a motor and the output voltage waveform is not distorted, then HPS50000TL-US-208A can only drive a 6HP motor.
- B. If you want the HPS50000TL-US-208A to drive more motors, you need to connect the VFD between the HPS50000TL-US-208A and the motor.



### 3.4 The layout of the main parts

#### 3.4.1 External layout



Figure 3-4-1-1 Inverter appearance

No.	Name	Description
1	Display	Inverter setting, browsing and operation status display
2	Cable inlet and outlet	For input and output power cable connection
3	Heat dissipation screen	For hot air ventilation

#### Indicator

There are 3 LED indicators on the inverter which is used to display the current status of the inverter.

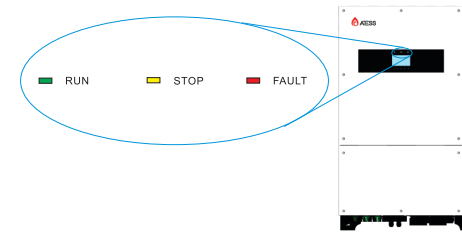

Figure 3-4-1-2 LED indicators

LED	Description
RUN	Lit when inverter is in normal operation
STOP	Lit when inverter is stopped
FAULT	Lit when inverter is in fault condition

#### Cable inlet and outlet

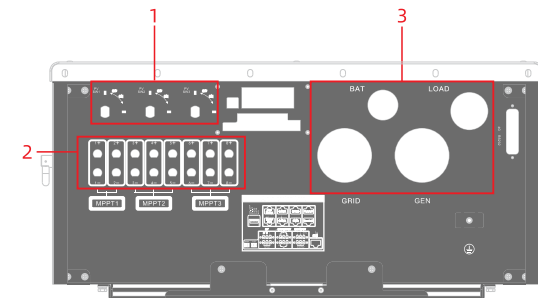

Figure 3-4-1-3 Inverter cable inlet and outlet

No.	Port	Description
1	SWITCH I	PV DC switch
2	INPUT I	PV cable gland
3	BAT/LOAD/GRID/GEN	Cable gland for BAT LOAD/GRID



### 3.5 Working mode

HPS50000TL-US-208A is designed with flexible working modes:

#### 3.5.1. Off-grid mode

##### ● PV POWER > LOAD POWER

When the PV power is greater than the load power, the PV gives priority to the load and the remaining power charges the battery.

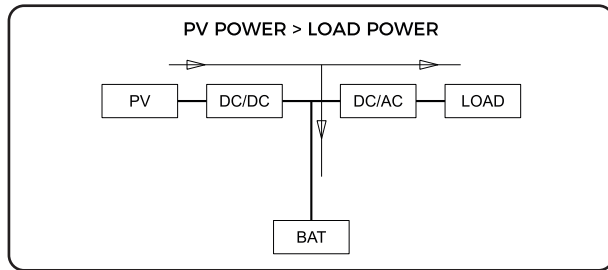

##### ● PV POWER < LOAD POWER

When the PV power is less than the load power, the battery discharges automatically. If the battery discharges to the undervoltage protection point, the HPS stops the AC output and transfers to the PV charging mode only, and the battery is charged to a certain level and resumes discharging.

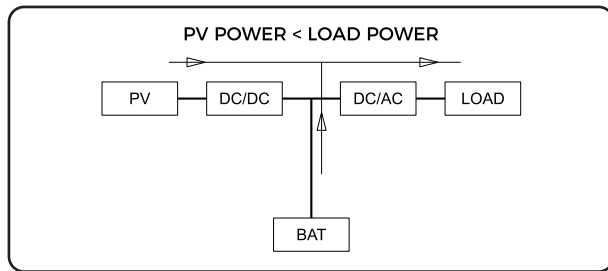

#### 3.5.2 On-grid load first mode

##### ● PV POWER > LOAD POWER

When the PV power is greater than the load power, the PV gives priority to the load and the remaining power charges the battery.

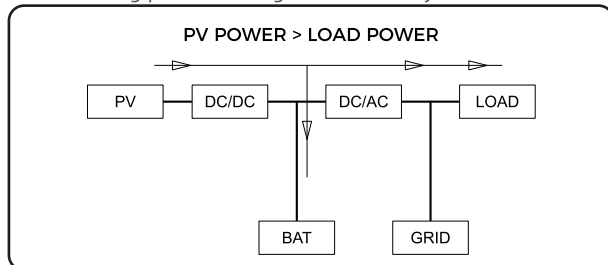

##### ● PV POWER < LOAD POWER

Automatic battery discharge. If the battery is discharged to the undervoltage protection point, the PV and the grid together to the load power supply, in order to protect the battery, will use small power energy to the battery trickle charging, the battery charging to a certain level can be restored to the power supply.

A. Bat Compensate Grid Soc(Volt) < Bat Soc(Volt)

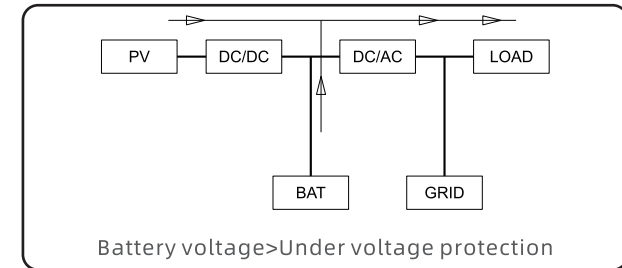

Battery voltage > Under voltage protection

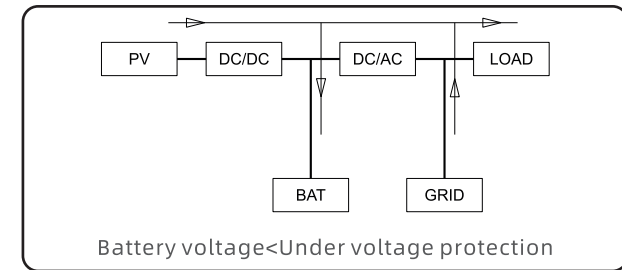

Battery voltage < Under voltage protection

Grid supplies the load

B. Bat Compensate Grid Soc(Volt) > Bat Soc(Volt)

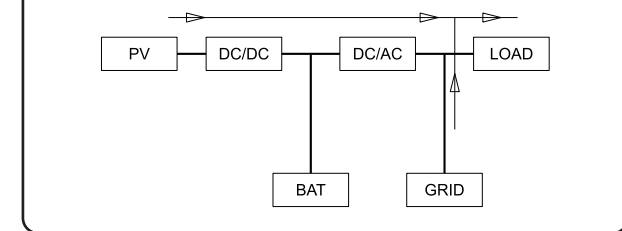

### 3.5.3 On-grid battery first mode

When the PV power is greater than the charging power, the PV gives priority to charging the battery and the surplus power is supplied to the load;

When the PV power is less than the charging power, the PV prioritises charging the battery and the grid supplies the load, while the grid also charges the battery.

If the grid-connected backup mode is not discharged or switched to other modes, in order to maintain the electrochemical activity of the battery, current-limited charging for one week, and then enter the battery discharge state, the battery discharge power is 20% of the rated output power.

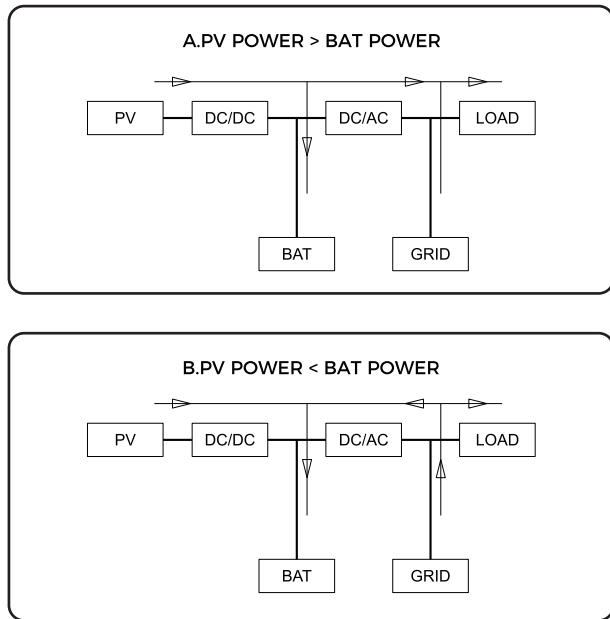

### 3.5.4 On-grid Economy Mode

Peak: Running Load Priority Mode

Valley: Running Battery Priority Mode

Flat:

The grid does not charge the battery and the battery does not discharge to carry the load.

When the PV power is greater than the load power, the PV carries the load and the residual power charges the battery.

when the PV power is less than the load power, the PV and the grid carry the load together.

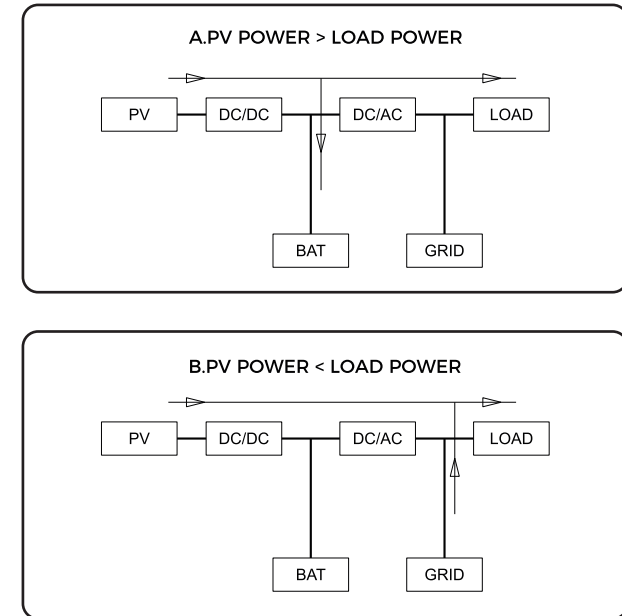

### 3.5.5 Generator Mode

#### 1. Generator connection (dry contact control)

In Off-grid mode: When battery discharging until GEN ON SOC (If no BMS, it will be GEN ON Voltage), HPs will switch-on GEN by dry contact to supply load and charge battery. HPs will consistently supply load during switching to GEN mode fully complete.

#### 2. When GEN is fully complete started

A. When PV is higher than charge power, PV will charge battery only.

B. When PV is lower than charge power, PV will priority charge battery. GEN will supply load then it is an option to let GEN charge battery or not according to customer's requirement.

C. When charging battery until GEN OFF SOC (If no BMS, it will be GEN OFF Voltage), HPs will switch-off GEN by dry contact then switch to Off-grid mode. when grid back, HPs will run Off-grid mode for a very short period, then switch to On-grid mode.

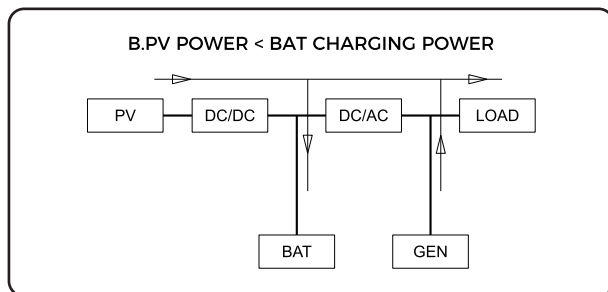
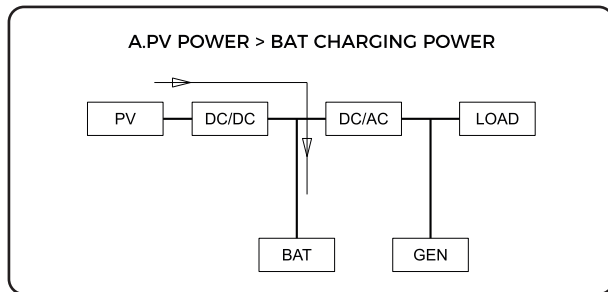

### 3.5.6 EMS mode

In EMS mode, the HPS is fully controlled by the EMS for charging and discharging, and all programmed working modes of ATESS will be invalid.

Controllable power includes PV power, inverter power and rectifier power (when not connected to the grid, only PV power can be controlled, inverter power is automatically adjusted according to the load). When set to inverter, DC output to AC, when set to rectifier, AC to charge the battery.

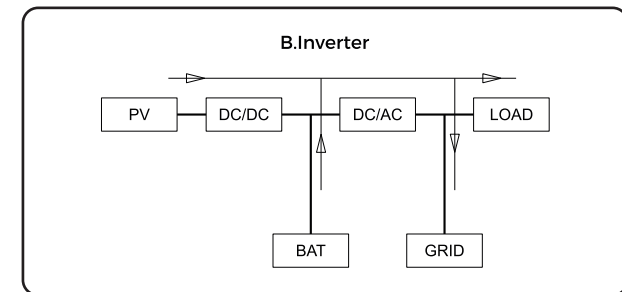
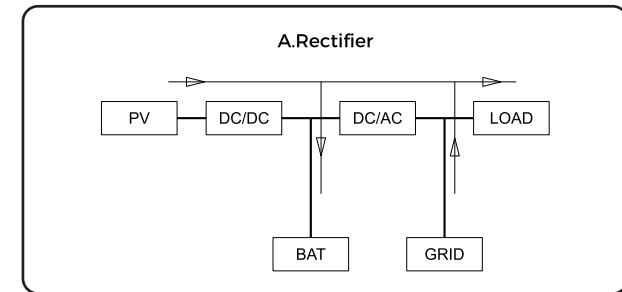

### 3.5.7 Smart Meter Mode

1) When the PV is greater than the sum of the critical loads, non-critical loads and battery charging power, the PV supplies power to the critical loads and non-critical loads, and the surplus power charges the battery:

a) The anti-reverse current enable is activated and the excess PV power may not be sent to the grid.

b) Anti-reverse current enable is not activated, excess PV power may be fed to the grid (feed power can be set).

2) When PV is greater than critical loads and non-critical loads, but less than the sum of charging power of critical loads, non-critical loads and batteries, PV supplies power to critical loads and non-critical loads, and the remaining power charges the batteries.

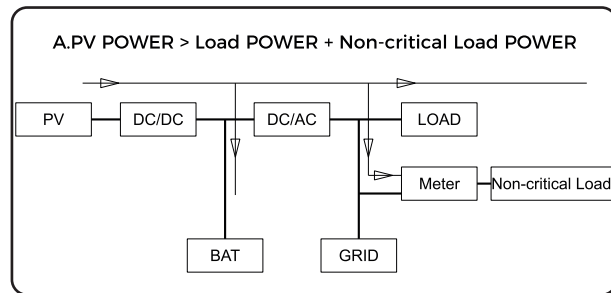

3) When the PV is greater than the critical load, but less than the critical load and non-critical load, the PV gives priority to the critical load, and the surplus power is supplied to the non-critical load:

a) The battery sends power to the meter to enable activation, and the battery and PV together supply power to the non-critical loads;

b) The battery sends power to the meter to enable inactivation, and the PV and the grid jointly supply the non-critical loads.

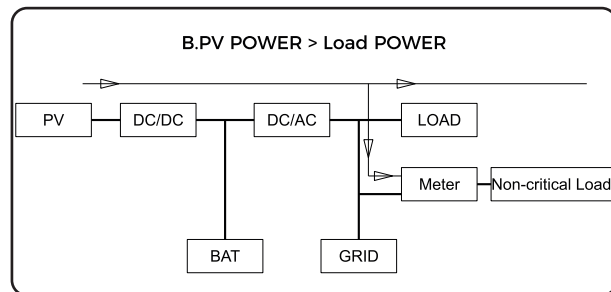

4) The PV is less than the critical load, and the PV and battery together supply power to the critical load:

a) The battery enables activation to the non-critical load, and the battery or the battery and the grid jointly supply power to the non-critical load.

b) Battery enablement to the non-critical load is not activated and the grid supplies power to the non-critical load.

**Note:** The sum of the inverter power of the PV and the battery must not exceed the rated power of the HPS.

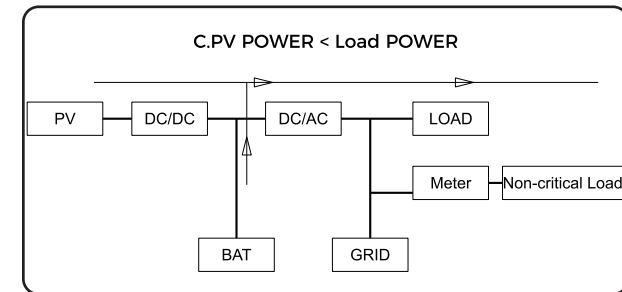

### 3.5.8 BAT-Smart Meter Mode

1) When the PV power is greater than the sum of the battery charging power and the critical load power, the PV prioritises charging the battery and supplying power to critical and non-critical loads:

- a) The anti-reverse current enable is active and the excess PV power may not be sent to the grid.
- b) Anti-reverse current enable is off, excess PV power can be fed to the grid and the feed power can be set.

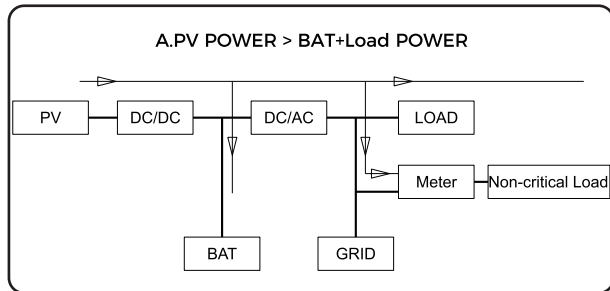

2) When the PV power is greater than the battery charging power, but less than the sum of the battery charging power and the critical load power, the PV gives priority to charging the battery, the excess PV power is fed to the critical load, and the grid feeds the remaining load.

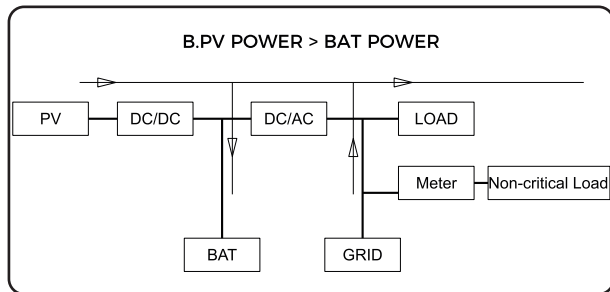

3) When the PV power is less than the battery charging power, the grid gives priority to charging the battery and supplying the loads at the same time.

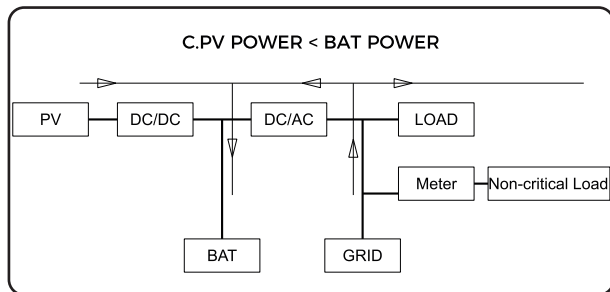

### 3.5.9 Multi-Stage (Dis)Charge Mode

(1) During non-set time periods, the system runs load priority mode.

(2) During the set time period

- a. If the current voltage (SOC) is higher than the set value, the system operates in load priority mode, in which case the PV and the battery can be fed to the grid, and the feed power can be set.
- b. If the current voltage (SOC) is lower than the set value, the system operates in battery priority mode.

### 3.5.10 On/Off-grid switch

Operation logic: When grid power on, HPS can switch into on-grid mode automatically, when grid power off, HPS can switch into off-grid mode automatically.

### 3.5.11 Fault mode

When the HPS energy system fails, the inverter will immediately disconnect the AC/DC contactor and enters into the fault mode, so as to ensure the safety of the system. Inverter continuously monitors fault status and will not enter charge and discharge mode until the fault is eliminated.

### 3.5.12 Permanent fault mode

When the HPS energy system fails, the inverter will immediately disconnect the AC/DC contactor and enters into the Permanent fault mode, so as to ensure the safety of the system. For example: inverter module failure etc. please contact your local dealer or ATESS directly when inverter enters permanent fault mode, repairmen on site is not allowed without authorization of ATESS.

## 3.6 Battery setting

Battery is an important part of energy storage system, strict protection is needed in the whole operation process. Protection threshold need to be set on HPS to ensure safe operation of battery, parameters including: battery quantity and unit quantity, capacity, charge current, discharge current, over voltage protection, under-voltage protection and so on. Battery parameter setting need to be done by professional personnel. Improper setting of battery will affect the normal working.

## 3.7 Storage

If there is a long time before installation or operation, the ATESS HPS50000TL-US-208A should be stored appropriately.

- The packaging should be restored to its original state.
- Retain the desiccant in the packaging.
- The ATESS HPS50000TL-US-208A can only be stored when it is stopped and all the doors are closed in a dry room to protect the internal circuits against dust and moisture.
- Storage temperature range: -40~55 °C
- Storage relative humidity range: 5 %~95 %
- Operating temperature range: -25~55 °C
- Operating relative humidity range: 5 %~95%
- Max. altitude: 2000 m

**CAUTION**  
 Strictly prohibited storage without packing!  
 · Avoid storage in direct sunlight!  
 · Keep upright and no stacking on top of the crate.



## 3.8 Packaging information

No.	Name	Unit	Quantity
1	Inverter main unit	pcs	1
2	Wall-mounting accessory	set	1
3	Expansion bolt	set	4
4	User manual	pcs	1
5	Certificate	pcs	1
6	Screw wrench	pcs	1
7	PV array terminal	set	1

Table 3-8-1 Packaging information

## 4.1 Installation condition requirements

To ensure normal operation of the machine, the installation environment is required as follows:

- The wall for mounting HPS should be solid and able to bear the weight of HPS in the long term.
- Installation space should be sufficient to cover HPS dimension, HPS dimension and installation gap please see below photo:
- Do not install HPS on flammable or heat vulnerable materials or buildings
- Do not install HPS in a space without good ventilation or dusty, it will cause low cooling fan efficiency, then reduce HPS efficiency, the fan and fan cover should be checked and cleaned every 6 months
- To avoid overheat and power derating, please do not expose HPS under the sun
- Environment temperature around HPS should be -25°C~55°C
- HPS can be installed on vertical or tilted surface as shown in below figure:

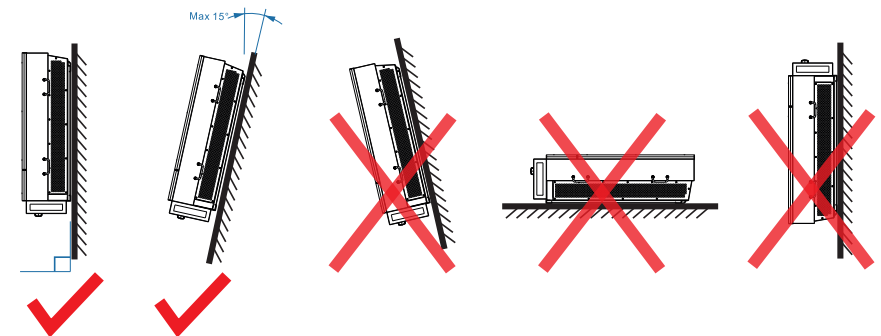

## 4.2 Installation environment

Although HPS is with IP65/Type 3R protection level, it is not recommended to install it under direct sun or direct rain/snow to ensure long term performance, below installation environment for reference:

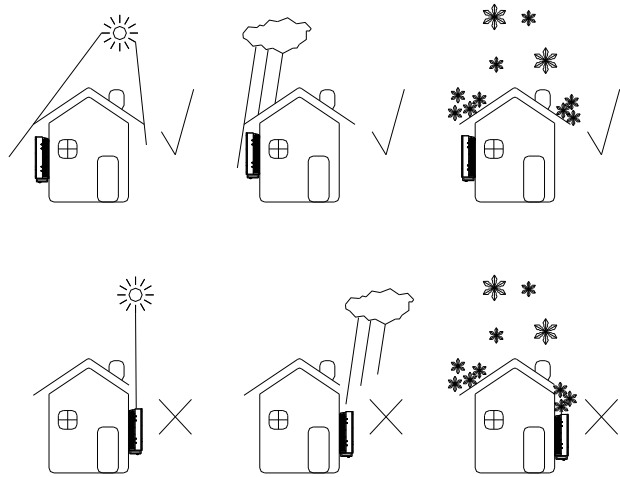

To avoid inverter life span decrease, it is recommended to install shading shield on top of inverter, distance between inverter and top shield please refer to below figure:

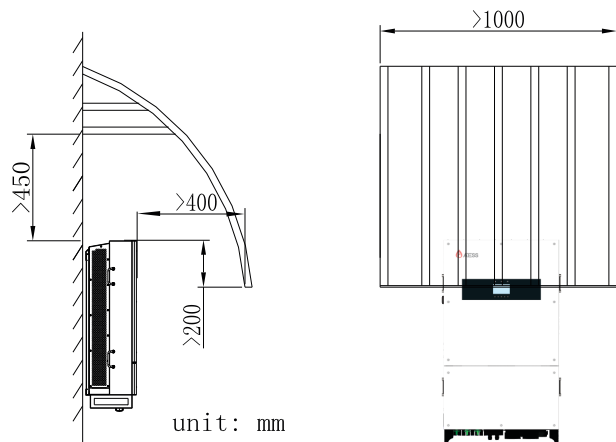

## 4.3 Space requirement

When installing HPS, reasonable distance should be kept for maintenance and ventilation, please refer to below figure:

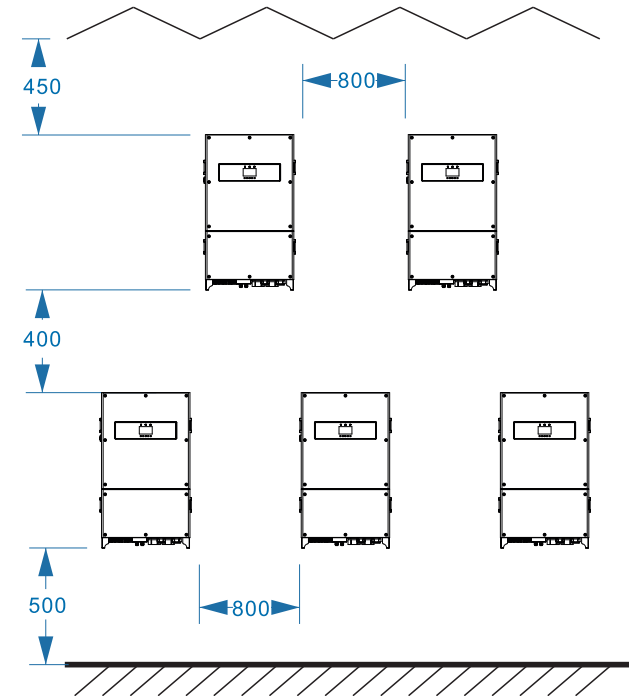

### Warning:



When environment temperature is too high, inverter derating is normal operation, but if derating occurs frequently, please check inverter heat dissipation surface or consider to move inverter to area with better ventilation. If fan is dirty please clean, if inverter inner fault please seek for professional service.

## 4.4 Tools for installation

Tools and spare parts required for installation is as follows:

- Hoisting crane, forklift or fork lift truck (with the capacity for bearing the weight of the inverter)
- Torque wrench
- Screwdriver
- Wire stripper
- Terminal crimping machine
- Heat dryer
- Megger and multimeter

## 4.5 Mechanical installation

### 4.5.1 Installation of wall-mounting kit



Before installing the wall-mounting kit, please check and make sure there's no electric cable and gas pipe in the location of installation.

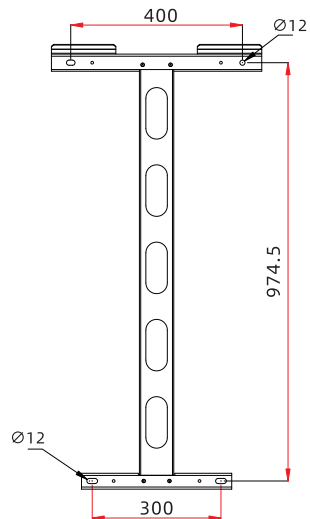

Figure 4-5-1-1 installation gap

### Steps:

A: Please drill the hole according to the hole mask.

B: Please install the expansion bolt as shown.

C: Please install the wall hanger as shown in the picture.

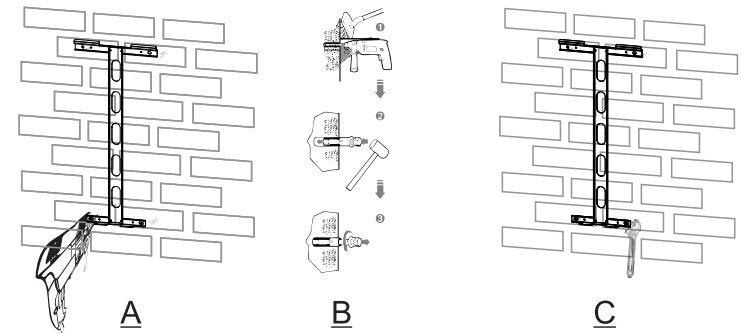

Figure 4-5-1-2 bracket installation



Note: wall-mounting bracket must be installed first before installing HPS

### 4.5.2 Installing HPS

Install HPS and stand-alone wiring diagrams, as well as parallel wiring diagrams

A. keep the inverter balance when hanging it to the bracket

B. Tighten the fixing screw

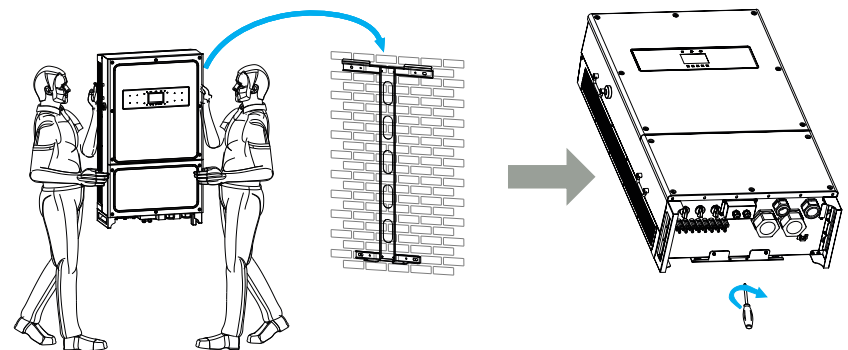
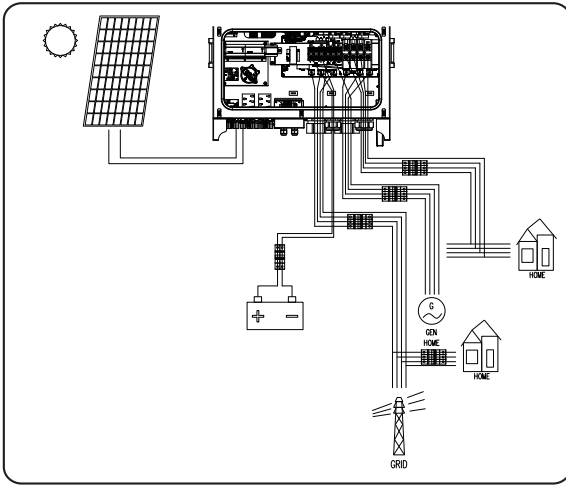

Figure 4-5-2-1 Hanging of inverter

## 4.6 Electrical installation

### 4.6.1 Electrical Parallel Wiring Diagrams(HPS50000TL-US-208A)



1.Wiring diagram of a single HPS50000TL-US-208A

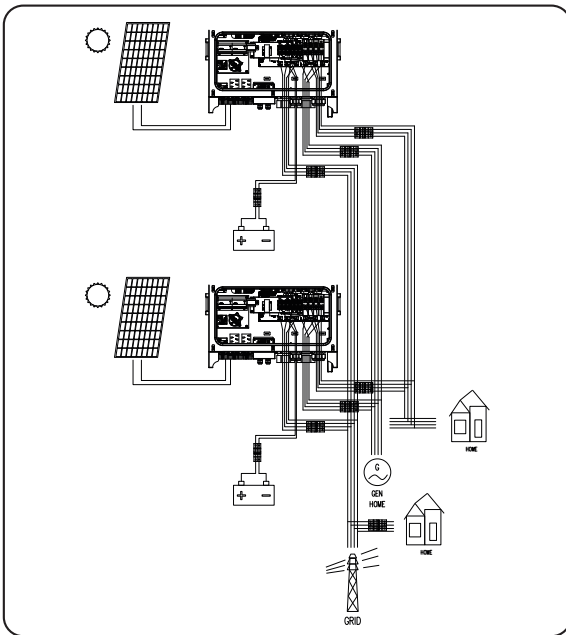

2.Parallel wiring diagram of independent battery  
HPS50000TL-US-208A

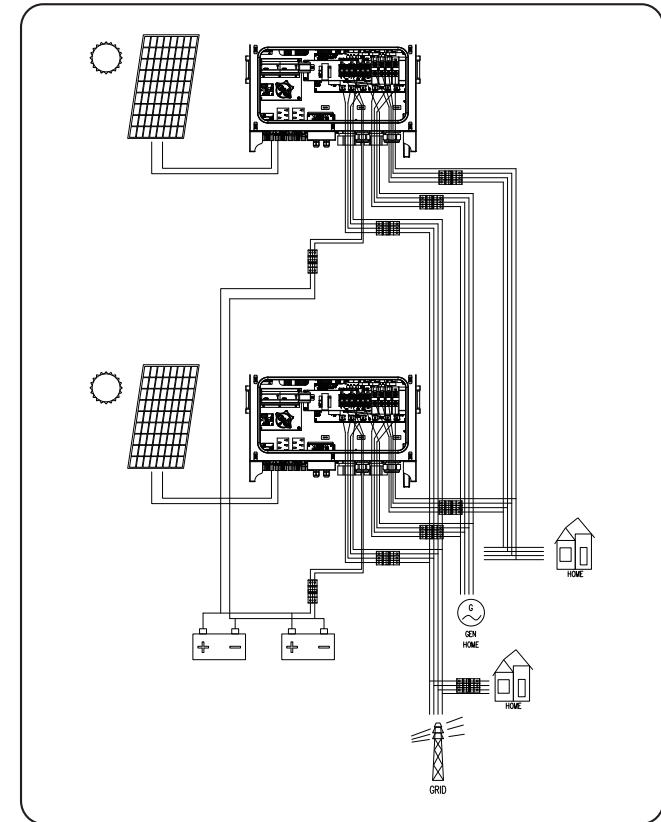

3.Parallel wiring diagram of a HPS50000TL-US-208A with  
batteries connected in parallel



#### Parallel System Wiring Requirements for Power Lines:

When using HPS50000TL-US-280A in a parallel system, please ensure that the power cables for the generator, battery, load, grid, and PV are of the same length and cable type. This is to ensure balanced current flow between the units during parallel operation.

## 4.6 Electrical installation

### 4.6.2 Input and output requirements

**NOTICE**

Caution, risk of danger



- There is a danger of electrical shock of high voltage in inverter's operation; only electricians of professional skills can operate.
- All connections with this equipment shall be done under non-voltage state.
- The inverter may be damaged if input or output terminal is ncorrectly plugged.

Failure of acting upon this information may cause serious.

#### 1) Battery

Battery string voltage should not exceed 680V, or else inverter will be in faulty mode

#### 2) Three-phase grid

Inverter will continuously inspect whether the grid satisfy the grid connected conditions. The following is the grid limit for satisfaction of local Grid connected onditions (requirements in different countries may vary, the value can be setup nd please refer to local grid connected regulations for details), and the grid is three-phase grid. Meanwhile, it shall be permitted by local power supply epartment before install Grid-connected inverted power.

Model	ATESS HPS50000TL-US-208A
Grid Voltage Limit	187.2V~228.8V
Grid Frequency Limit	48HZ-52HZ/58HZ-62HZ

Cable (Copper)	Cable Diameter Requirements (mm <sup>2</sup> /AWG)	Aperture
Model	ATESS HPS50000TL-US-208A	
PV +-	Input cable with each at least 4 mm <sup>2</sup> /12-10AWG	/
BAT +-	Cable with each at least 25 mm <sup>2</sup> /3AWG	M6, 7N*m/62 in-lb
Grid input L1 L2 L3	Input cable with each at least 25 mm <sup>2</sup> /3AWG	M6, 7N*m/62 in-lb
GEN input R S T	Input cable with each at least 25 mm <sup>2</sup> /3AWG	M6, 7N*m/62 in-lb
Load output U V W	Input cable with each at least 16 mm <sup>2</sup> /6AWG	M6, 7N*m/62 in-lb
Communication Wire	0.25mm <sup>2</sup> /24-22AWG, shielded twisted pair is recommended	M2,0.2N*m/1.8 in-lb
Earth Wire	More than 6 mm <sup>2</sup> /9AWG.Green and yellow is recommended	M6, 7N*m/62 in-lb
N wire	Cable with Load N or Cable with Gird N at least 10mm <sup>2</sup> /7AWG	M6, 7N*m/62 in-lb

### 4.6.3 Preparation before cable connection

Before wiring, you need to open the front door of the energy storage controller. The specific steps are as follows:

Step 1: Turn off the AC and DC switches. As shown in the figure below, the PV switch is in the "OFF" state.

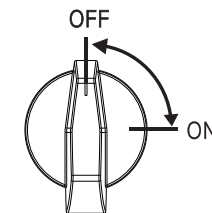

### 4.6.4 DC side wiring

**NOTICE**

Caution, risk of danger



1. ATESS HPS50000TL-US-208A of AC and DC, do not have switches or circuit breakers, customers need to add their own switches, or buy our company design and production switch box.
2. The positive and negative of the battery shall not be connected in reverse. A multimeter shall be used to determine the polarity first, and then connect into the corresponding input ends of the inverter. Specific procedures are as follows:

Step 1: Cut off the distribution circuit breaker at the DC side, and ensure that no voltage on the wire at DC side.

Step 2: Confirm the battery positive and negative voltage within range with a multimeter.

Step 3: Confirm the negative and positive pole with a multimeter

Step 4: Peel the insulation layer of cable

Step 5: Fix cable lug

1. Place the stripped copper core into the crimping holes of the cable lug
2. Press the cable lug with the terminal crimping machine. The number of crimps should be more than two

Step 6: Fix heat shrinking tube

1. Choose heat shrink tube according to cable size, and cut about 5cm
2. Fix the tube to cable, cover the lug hole
3. Use air heater to blow the tube and make it shrink

Step 7: Connect the "Bat+" end of the energy storage controller to the positive terminal of the battery pack with a cable.

1. Pass the cable through the PG waterproof connector.
2. Secure the copper noses at the ends of the wiring to the "Bat+" end of the energy storage controller and the positive terminal of the battery pack.
3. Fasten the bolt with a screwdriver or wrench

Step 8: Connect the "Bat -" end of the energy storage controller to the negative terminal of the battery pack by cable according to the method of step 7.

Step 9: Connect the "PV+" end of the energy storage controller to the positive pole of the battery board by cable according to the method of step 7.

Step 10: Connect the "PV-" end of the energy storage controller to the negative pole of the battery board by cable according to the method of step 7.

Step 11: Make sure the wiring is secure; tighten the PG waterproof connector

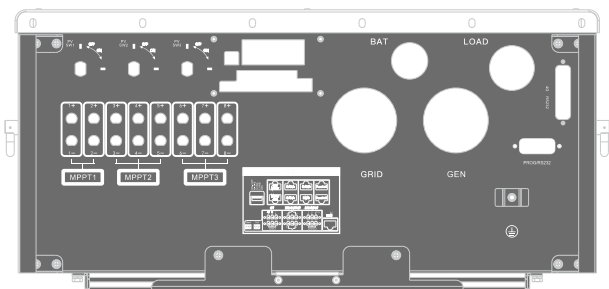

#### 4.6.5 AC side wiring



##### NOTICE

Caution, risk of danger

When connecting the AC grid, cut off the circuit breaker at the AC side to ensure that the AC wire connecting to terminals has no electricity.

Connect AC grid:

- 1) Cut off the circuit breaker at AC side, to ensure that the AC wire connecting to terminals has no electricity. Confirm it with a multimeter.
- 2) Confirm the phase sequence of grid
- 3) Peel the insulation layer of cable
- 4) Fix cable lug
- 5) Fix heat shrink tube
  - a. Choose heat shrink tube according to cable size, and cut about 5cm
  - b. Fix the tube to cable, cover the lug hole
  - c. Use air heater to blow the tube and make it shrink
- 6) The diesel generator should be connected to the HPS terminals GEN-R, GEN-S, and GEN-T, and the grid should be connected to terminals Grid-L1, Grid-L2, and Grid-L3.

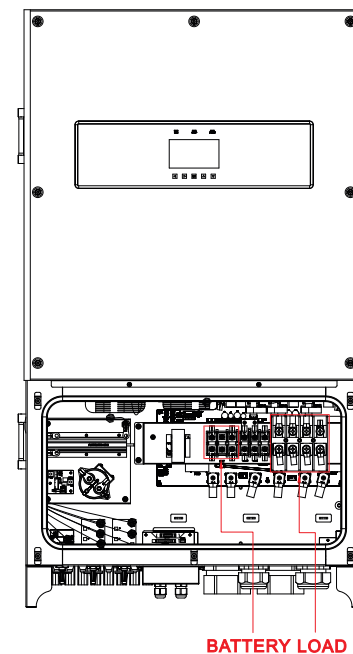

Figure 4-6-1-1 AC output cable connection

#### 4.6.6 Earthing

Inverter must be earthing well for safety; Please make sure of the connection between PE in power distribution cabinet and PE terminal in the inverter good; and make sure the earthing cable more than 6mm<sup>2</sup> and the earthing resistance must below 4 OHM.

Inverter earthing busbar please refer to above photo cable inlet and outlet are on the bottom of inverter, after finishing connection, tighten the cable tighten gland.



Note: the PE busbar is for grounding inside inverter, please do not change to avoid electric shock risk

### 4.7 Communication

The HPS series hybrid energy storage system has multiple communication modes. When users need to monitor the operation status of the energy storage and discharge system, RS485 serial port or CAN communication mode or WIFI or 4G can be used for power supply.

#### 4.7.1 RS485

Users can directly use the RS485/RS232 converter for host computer communication. The HPS communicates with the HPS through RS485, and finally communicates with the PC through the RS485 to RS232 datalogger, runs the monitoring software in the PC, and monitors the running status of the single/multiple energy storage controllers in real time.

RS485 communication line uses terminal blocks at both ends, and RS485 communication lines are made by parallel connection of terminals at both ends. The length should not exceed 1000 meters. As shown in Figure 4-7-1-1.

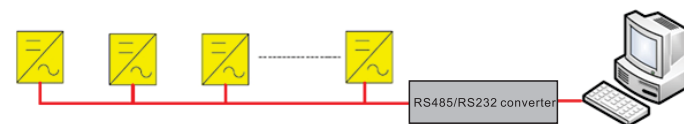

Figure 4-7-1-1 PC monitor through RS485

#### 4.7.2 CAN communication

Rate of CAN communication is between 100K and 500K, and the shielded twisted pair is used for communication to ensure communication quality.

#### 4.7.3 WIFI or 4G communication

WIFI or 4G is an optional configuration, need to buy WIFI communication module or 4G communication module

### 4.8 Installation inspection

Before the inverter is put into operation, it shall be inspected for installation. Two working men or more shall inspect to ensure correct installation of all installation according to the following table.

Mechanical inspection	
<input type="checkbox"/>	Inverter's bottom is fixed, and the support is stable and reliable.
<input type="checkbox"/>	Enough space is left around inverter.
<input type="checkbox"/>	The ambient temperature, humidity and ventilation satisfy requirements.
<input type="checkbox"/>	Smooth flow of cooling air.
<input type="checkbox"/>	Complete and reliable sealing protection of cabinet.
<input type="checkbox"/>	No deformation and damage to inverter.

Electrical Installation Inspection
<input type="checkbox"/> Complete and firm grounding of inverter.
<input type="checkbox"/> Grid voltage matching the rated input voltage of inverter.
<input type="checkbox"/> Correct phase sequence of grid connection, and tightening torque meeting requirements.
<input type="checkbox"/> Correct connection of DC input anode and cathode, and tightening torque meeting requirements.
<input type="checkbox"/> Correct connection of communication lines, and maintaining a certain distance to other cables.
<input type="checkbox"/> Mechanical Installation Items Inspection
<input type="checkbox"/> Other Inspections
<input type="checkbox"/> All useless conductive parts tied with insulating ribbon.
<input type="checkbox"/> No tools, spare parts, conductive dust generated from drilling or other matters left inside the cabinet.
<input type="checkbox"/> No condensed humidity or icing inside the cabinet.

Table 4-8 Installation Inspection List

The chapter will introduce the procedure of pilot operation, including checking battery voltage, input and output connecting, other preparation working.

## 5.1 Relevant requirements

Before pilot operation, the installation conditions of the equipment shall be examined thoroughly, in particular whether voltages at DC and AC ends are consistent with inverter's requirements, and whether the polarity etc. are correct. Inspect if the system connection meets requirements in relevant standards or codes and if the system is grounded well.



**CAUTION!**

Before pilot operation, all switches at AC side and DC side shall ensure to be cut off.

## 5.2 Inspection

### 5.2.1 Inverter inspection

Before power on the inverter, please carry out inspections as the following procedures:

Step 1: Inspect inverter's installation and wiring conditions based on the Installation

Inspection List in Table 4-8

Step 2: Ensure the AC&DC circuit breakers are cut off

### 5.2.2 Grid voltage inspection

Inspect whether the three phases of the inverter is correctively connected with the three phase sequence of the grid. Inspect whether the line voltage and frequency are within the prescribed range, and record the value. If possible, measure the phase THD (Total Harmonic Distortion), and inspect the curve. If distortion is serious, the inverter may fail to operate.



**CAUTION!**

When connecting the load, make sure that the three-phase of the load is corresponding to the three-phase of the HPS, otherwise it will cause the motor to reverse.



**Warning:**

- After manually shutting down, you must press the power button on the LCD, otherwise cannot start automatically.
- Still powered after manual shutdown

### 5.2.3 DC side voltage inspection

The DC side consists of two parts, from the confluence box or the DC distribution cabinet to the HPS and from the storage battery to the HPS. Ensure that the direct current from the confluence box or DC distribution cabinet is connected to the PV terminal of HPS and is in sequence.

- Make sure the DC input polarity is correct.
- Measure and record each DC (open circuit) voltage. The voltage value of each channel should be almost the same and should not exceed the maximum allowable DC voltage value.
- Battery voltage check, battery parameter setting check

### 5.3 Power on steps

#### First power-on

Step 1: Close AC circuit breaker

Step 2: Close DC circuit breaker

Step 3: PV DC switch to ON position

Step 4: Click start on inverter display and wait till 'grid connecting

**Note:** when system is powered, 60S later about display will lit

#### Manual turn-off

During operation, you can click the shutdown button on the LCD, at this time the inverter stops working and stops sending power to the grid

### 5.4 Pilot operation completion

The following procedures shall be carried out after the inverter is normally in operation.

Procedure 1: Inspect whether abnormality exists in the inverter, such as excessive noise, excessive heat, abnormal smell or smoke.

Procedure 2: Measure whether inverter voltage, current and THD are stable.

Procedure 3: Operate LCD control panel and inspect whether it displays normally and accurately.

By now, the pilot operation of inverter is fully completed, and we can enter the daily operational maintenance.

### 5.5 Power off steps



**CAUTION!**

After the inverter is completely powered off, the general DC switch at battery side and the Grid switch at grid side still maintain voltage. If operations are needed, please be sure to cut off the outer power completely, and wait for not less than 20 minutes

1. Click the OFF button on LCD or turn the off-on knob from ON to OFF;
2. Cut off DC SWITCH;
3. Cut off GRID switch and load switch



During the power-off process, the energy storage controller sends an alarm as normal. You can continue the power-off step

# 6 HMI

## 6.1 Introduction to touch screen

Users can view the operation information of the energy storage controller on the LCD touch screen, as well as set the operating parameters of the energy storage controller. For ease of operation, the following is a distribution diagram of the LCD menu logic structure.

After the LCD is powered on, enter the boot interface, and about 15S enter the interface home page. At this time, you can start to operate the relevant keys for information review and parameter setting.

The upper right of each page shows the communication status between the LCD and the energy storage controller control board, the station number of the communication end where the energy storage controller is located, the system time, etc.

At the bottom of each page are five common function buttons: "Operating Data", "Historical Data", "System Settings", "Power On/Off", and "Home". With these five common keys, users can operate easily and quickly. On the left side of the interface, the submenu buttons corresponding to the above five commonly used keys are displayed, and the selected buttons are marked in green.

Operating Data	Warnings	System Settings	On/Off	Home
	Current fault	Language Settings		
	History fault	Time setting		
		Device information		
		Equipment maintenance		

## 6.2 Touch screen operation

### 6.2.1 Main page

Click the [Main Page] button at the bottom of any other interface to enter this page.

On this page, there are mainly information such as operating status, battery power, grid power and so on. The common function keys under the LCD can be used to switch to other pages.

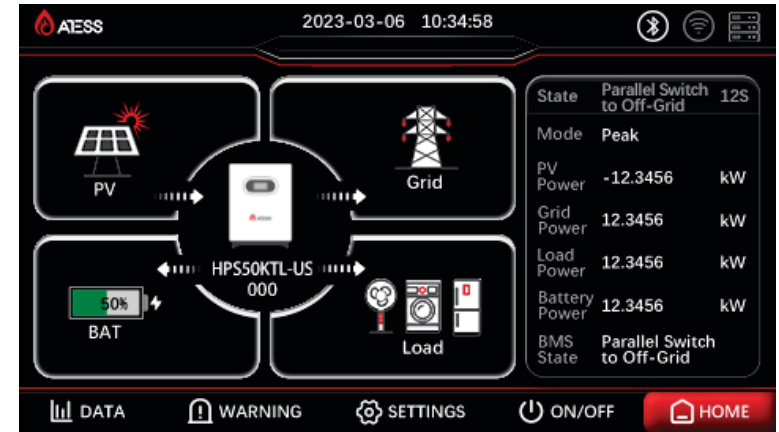

Running status displays content	Notes
Fault	The machine is not turned on or can not be turned on due to fault
Waiting	Boot initialization
Check	System self-test
Permanent	Serious failure occurred
Offline	Offline with load mode
OnGrid	Successfully connected to the grid
Single PV mode	PV charging only mode
Parallel_OffLine	The parallel system waits to enter the off-grid mode
Parallel_OnGrid	The parallel system waits to enter grid-connected mode

**Mode:** When the operating status of the energy storage controller is grid-connected, the current grid-connected mode will be displayed: load priority, battery priority, economic mode, peak shaving and valley filling, EMS mode, oil turbine mode, smart meter, multi-stage charge and discharge mode, etc.

**BMS status:** When the battery is a lithium battery with BMS, the current BMS status is displayed here. When there is no BMS communication, the "Waiting" status is displayed.

### 6.2.2 Power On/Off

Click the [Power on/off] button in any other interface to enter this page. In this page, the main ones are: boot button, shutdown button. Used to select the power on or off operation.

**Boot:** Click "ON" to boot the system.

**Shutdown:** Shut down, click "OFF" to shut down.

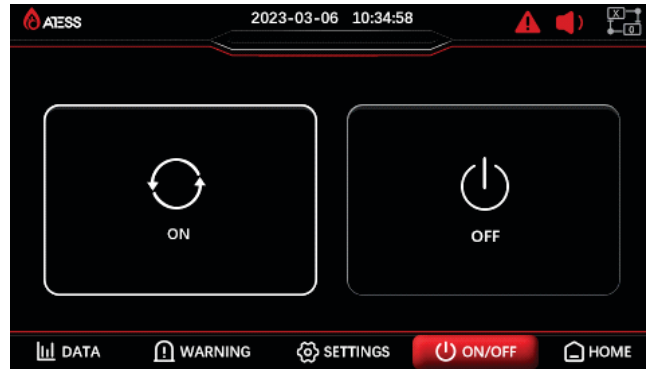

### 6.2.3 Operating Data

Click the [Run Data] button at the bottom of any other interface to enter the submenu of "Run Data". The submenus are: operating data, charge and discharge amount.

**Operational data:** Displays the current energy storage generation parameters and real-time data including grid voltage, grid frequency, grid current, battery voltage, battery current, temperature in the chassis, and total power generation time (real-time update).

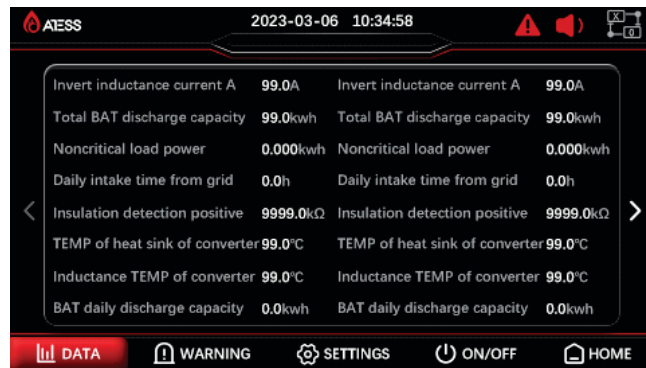

### 6.2.4 System settings

**Language settings:** Select the interface language under this page, currently only two languages, Chinese and English.

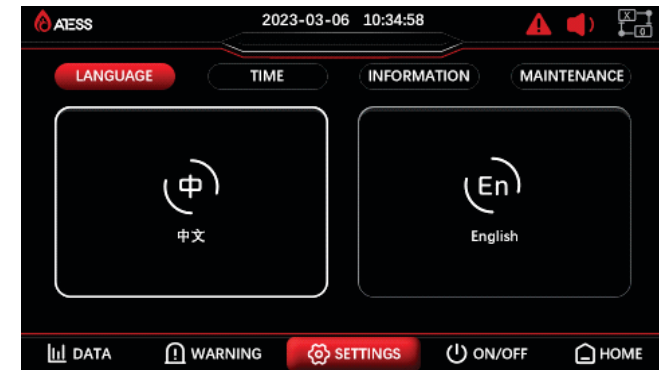

**Time:** Set the system time under this page (you can modify it here when the time and date displayed by the LCD do not correspond to the actual local time date).

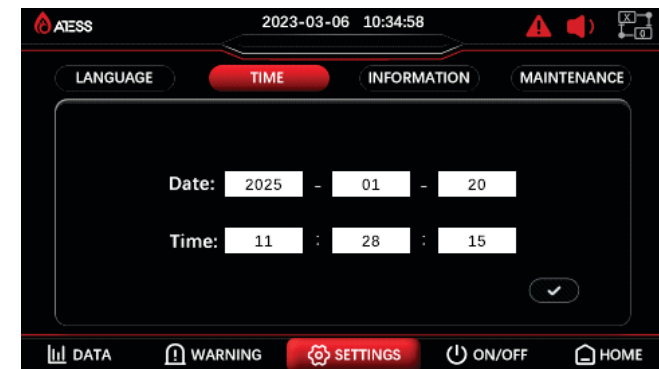

**Information:** The manufacturer, serial number, software and hardware version information, and factory date information are displayed under this page, which only shows that it cannot be modified.

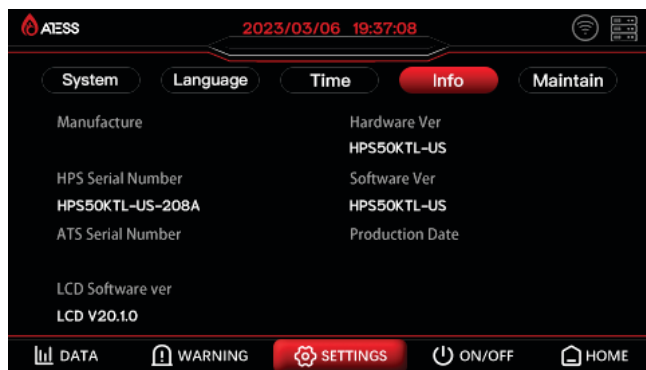

**Maintenance:** The interface requires a password to log in, the password is provided by technical support, only electricians or maintenance personnel who are fully familiar with the composition and working principle of the entire equipment system can operate this item, so as not to cause damage to personal safety and energy storage controller performance, please operate with caution.

### Protection parameters

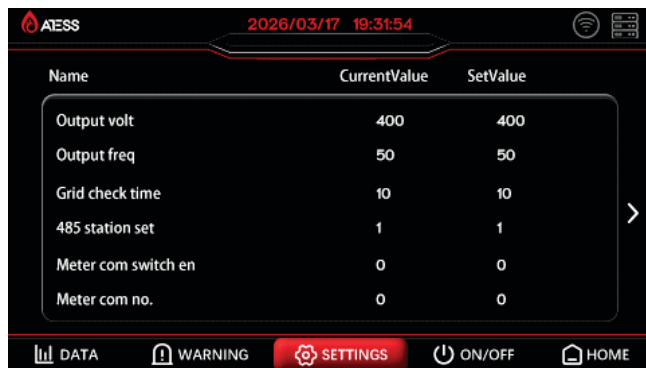

**Output Volt:** Set the off-grid output voltage, you can set 380 or 400, which can be changed according to actual needs, and you need to power off and restart after the change to take effect.

**Output Freq:** Set the AC output frequency, you can set 50 or 60, you can change it according to actual needs, and you need to power off and restart after the change to take effect.

**Grid check time:** Boot detection time, default preset 60 seconds, minimum 10 seconds, maximum 300 seconds.

**485 station set:** The number represents the current station number, which is the 485 communication station number.

**Meter com Switch Enable:** Set to 0 when the meter is connected and the collector produced by ATESS is connected; Connect only the meter to 1.

**Meter com no:** Set the 485 communication address of the meter.

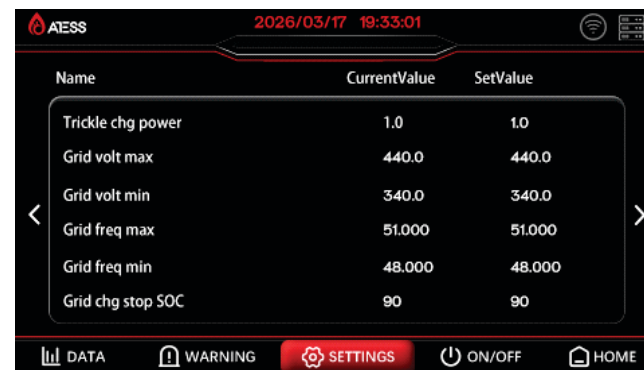

**Trickle charge power:** Only valid in "load priority" and "peak period" of economic mode, when the battery is loaded to the discharge cut-off, the battery stops discharging, is carried by the grid, and charges the battery at the set power.

**Grid Volt max:** The upper limit of the grid voltage, beyond which it will be cut into off-grid mode, which is set by 110% of the rated value.

**Grid Volt min:** The lower limit of the grid voltage, below which it will cut into off-grid mode, and the default setting is 85%.

**Grid Freq max:** The upper limit of the grid frequency, beyond which it will switch to off-grid mode, the default setting is rated +2.

**Grid Freq min:** Lower grid frequency, below which it switches into off-grid mode, with the default setting of -2.

**Grid charge stop SOC, Grid charge stop Voltage:** When the battery voltage or SOC reaches the set value, stop charging the battery from the grid.

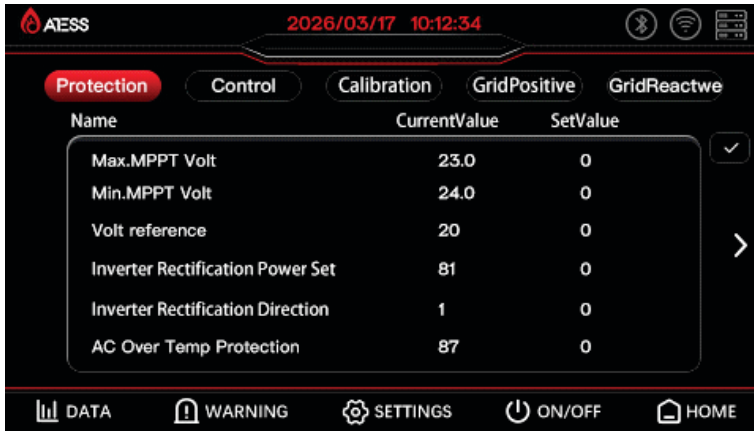

**Max.MPPT Voltage:** PV voltage limit.

**Min.MPPT Voltage:** The lower limit of PV voltage.

**Voltage reference:** The bus voltage sets the reference value, the default is 730V.

**Inverter Rectified Power Set:** Only active in EMS mode, set the power of machine rectification or inverter.

**Inverter Rectified Direction:** Only valid in EMS mode, set "0" direction to rectification, set "1" direction to inverter.

**AC Over Temp Protection:** Reserved.

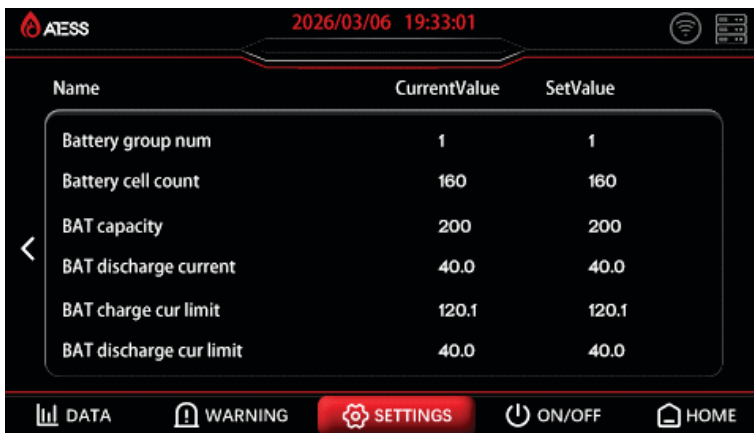

This page is the battery parameter setting page, the battery is an important part of the energy storage control system, and the battery parameters need to be carefully confirmed whether they are consistent with the actual situation.

**Battery group num:** The number of battery modules connected in parallel. If 2V/200Ah, 240 strings are 2 merged, the number of groups is 2.

**Battery cell count:** The number of individual cells of the battery module.

**BAT Capacity:** Single battery capacity, unit Ah. If 2V/200Ah, 240 series 2 merge, the capacity is 200Ah.

**BAT discharge current:** The size of the battery discharge current.

**BAT. Charge cur limit, BAT discharge cur limit:** Battery current protection value. Used to determine whether the battery is over-current.

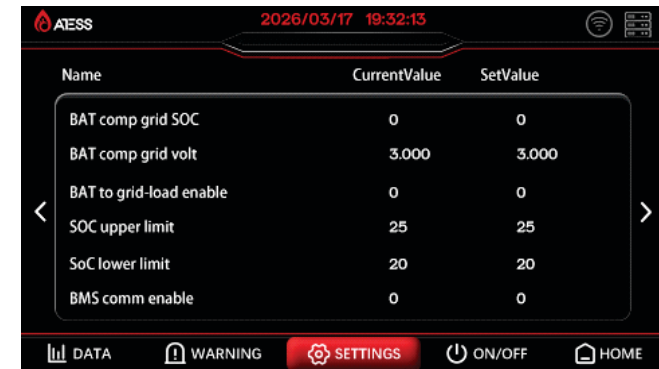

**BAT Compensate Grid SOC, BAT Compensate Grid Volt:** Only in the "load priority" and "peak period" of the economic mode, when the battery voltage or SOC is greater than the set value, the priority battery with load; When the battery voltage or SOC is less than the set value, the grid is loaded first.

**BAT to grid -load enable:** Reserved.

**SOC UP Limit, SOC lower Limit:** Only take effect when the battery has BMS, which is used to determine whether the battery is under voltage and resume discharge.

**BMS Communication enable:** Set to 1 when the storage controller communicates with the battery BMS; Otherwise, set to 0.

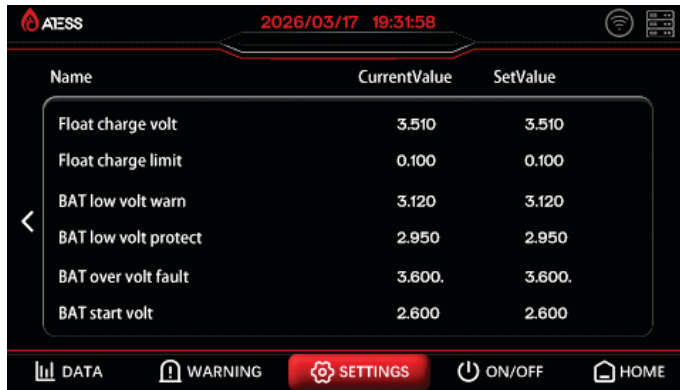

**Floating Charge Volt:** The voltage value of the float charge unit of the battery. When the battery cell voltage reaches this set value, the charging current approaches 0A.

**Float Charge Volt Limit:** The voltage value of the battery into the float state, when the battery cell voltage is greater than (float voltage - float charge current limiting point), the battery begins to enter the float state, the charging current gradually decreases, and the charging current is 0A when the float voltage is reached.

**BAT low Volt Warning:** The unit voltage value when the battery under voltage alarm.

**BAT over Volt fault:** The unit voltage value when the battery over voltage fault.

**BAT Start Volt:** When the battery cell voltage of the energy storage controller reaches the starting voltage, the energy storage controller can start.

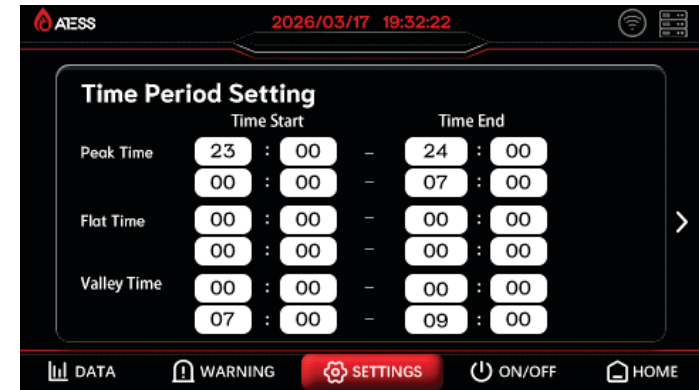

**Peak Time, Flat Time, Valley Time:** Only in effect in the "Economic Mode" and is used to set the time period range of peak, flat, and valley periods.

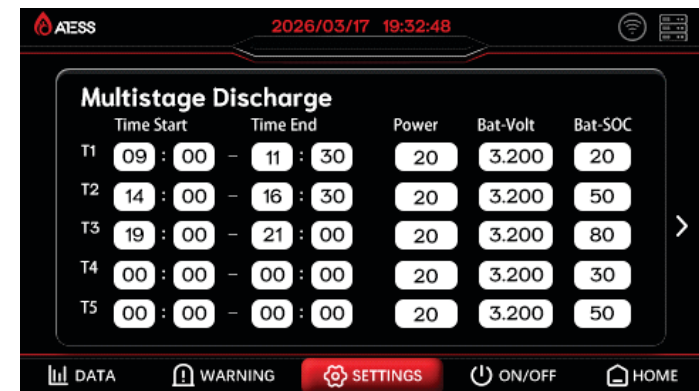

"Multi-stage charge and discharge" mode parameter setting interface:

**Time:** Used to set the usage period.

**Power:** The maximum discharge power limit of the battery.

**Batt Volt, Batt SOC:** When the battery cell voltage or battery SOC is greater than the set value, the machine runs the load priority logic, and the priority battery discharge with load; When less than the set value, the machine runs battery priority logic and priority grid discharge with load.

## Control instructions

Name	CurrentValue	SetValue
Mmeter CT ratio	10	10
Islanding protect en	1	1
PSG enable	0	0
PSG rated power	0	0
CANb baud rate	20	20
RS485 baud rate	9600	9600

**Meter CT Ratio:** The ratio of meter CT.

**Islanding Protect Enable:** A protection function that prevents the energy storage controller from correctly cutting into the off-grid mode under abnormal grid conditions.

**PSG Enable, PSG rated power:** Reserved.

**CANb baud rate:** The baud rate setting of CANb.

**Rs485 baud rate:** The baud rate setting of RS485.

Name	CurrentValue	SetValue
ATS enable	0	0
ATS count	1	1
ATS comm station	0	0
ATS station enable	0	0

**ATS Enable:** When the energy storage inverter is connected to ATS, the ATS enable needs to be modified to 1; Otherwise, set to 0.

**ATS count:** Reserved.

**ATS comm Station:** Reserved.

**ATS Station Enable:** Reserved.

Name	Current Value	Set Value
Model Select	0	0
0: Load	1: Bat First	2: Time shifting
3: Peak shaving		4: EMS mode
5: Smart meter mode		6: Batt-smart meter
7: Multi-stage charge and discharge		8: Constant power discharge
9: Force charge		10: Generator mode

**Mode Selection:** Set the mode of inverter operation.

0: load priority.

1: battery priority.

2: economy mode.

3: peak shaving and valley filling.

4: EMS mode.

5: smart meter.

6: battery smart meter.

7: multi-stage charge and discharge.

8: Constant power discharge.

9: Force charge , 10: Generator mode.

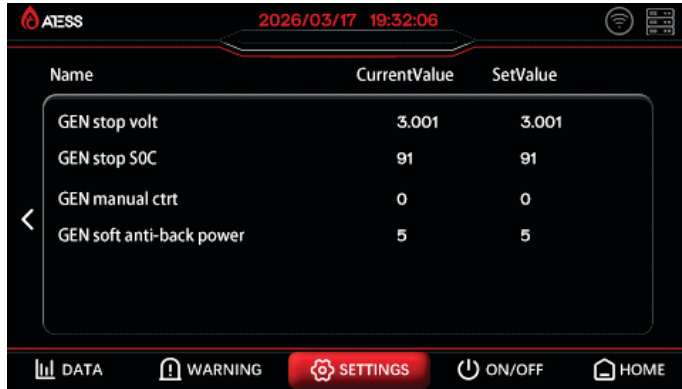

**GEN Stop Voltage:** When the oil machine is enabled, when the battery voltage reaches the set oil turbine stop voltage , the inverter controls the dry contact to turn off the oil machine.

**GEN Stop SOC:** When the oil machine is enabled, when the battery SOC reaches the set oil turbine stop SOC, the inverter controls the dry contact to turn off the oil machine.

**GEN manual Ctrt:** Reserved.

**GEN soft anti-back power:** The starting power of the generator is controlled to prevent the reverse flow of electricity to the generator.

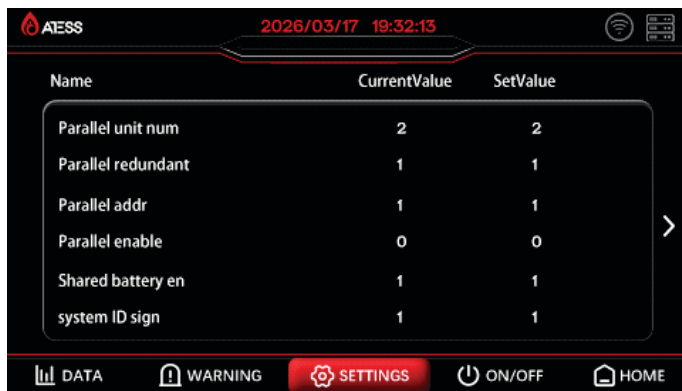

**Parallel unit num:** The total number of devices in the parallel system, 2 devices are set to 2 and 3 are set to 3.

**Parallel Redundant Number:** The maximum number of faults that can be faulted in the parallel system can only be set to 0 or 1. When set to 0, when any device in the parallel system fails, all devices will be transferred to the fault; Set to 1, when the number of faults is not greater than 1, other devices still operate normally (the maximum number of supported faults is 1).

**Parallel addr:** The sequencing of this equipment in the parallel system.

**Shared battery Enable:** If set to 1, The redundant system shares one battery.

**Parallel Enable:** If set to 1, the parallel function is enabled, and all devices participating in parallel must be set to 1.

**System ID Sign:** Used for the server to identify the energy storage system, the same set of parallel system set the same number, otherwise set a different number, the stand-alone system is set to 0.

### Factory Settings

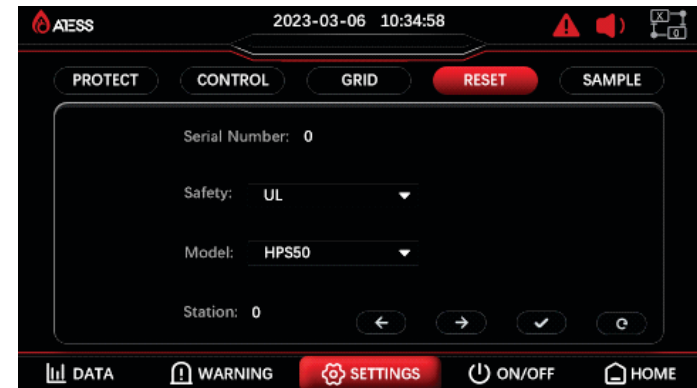

The parameters on this page are important parameters and factory preset parameters, please do not modify them without the consent of relevant personnel. The Company is not responsible for any consequences.

### 6.2.5 Alarm information



The parameters on this page are displayed for alarm information, which are divided into current faults and historical faults.

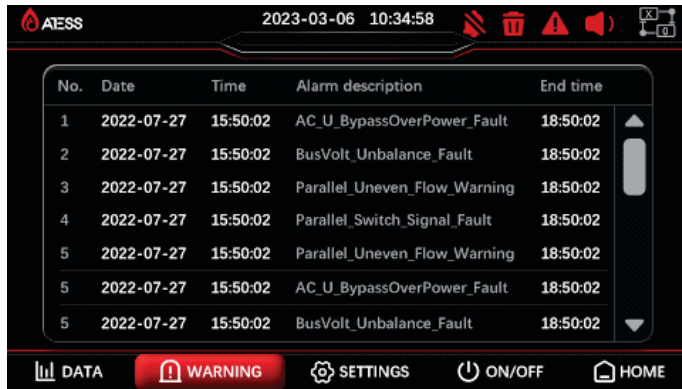

**Alarm information:** The fault reported by the energy storage inverter is displayed, the fault time is displayed on the left, and the corresponding fault name is displayed on the right.

### 6.3 LCD display information schedule

#### 6.3.1 General history failure table

No.	Description
1	PV_Reseverd_Failure
2	IGBT_Failure
3	EEPROM_Write_Failure
4	EEPROM_Read_Failure
5	AC_MainContactor_Failure
6	AC_SlaveContactor_Failure
7	GFDI_Failure
8	GFCI_Failure
9	RISO_Failure
10	BAT_MainContactor_Failure
11	AC_BypassOverPower_Failure
12	AC_U_BypassOverPower_Failure
13	AC_V_BypassOverPower_Failure
14	AC_W_BypassOverPower_Failure
15	BAT_Reseverd_Failure
16	Reseverd_Failure
17	PV2_OverVolt_Fault
18	BL_OCP_Fault
19	PV_OCP_Fault
20	BMS_Communicate_Fault

No.	Description
21	INT_PV2_OverCurr_Fault
22	BMS_Fault
23	BAT_OCP_Fault
24	INT_BUS_unbalance_Fault
25	PV1_OverVolt_Fault
26	INT_BAT_OverVolt_Fault
27	INT_PV1_OverCurr_Fault
28	INT_BAT_OverCurr_Fault
29	INT_INV_OverVolt_Fault
30	INT_INV_OverCurr_Fault
31	INT_BL_OverCurr_Fault
32	INT_BUS_OverVolt_Fault
33	AC_NoUtility_Fault
34	AC_GridPhaseSeque_Fault
35	AC_PLL_Fault
36	AC_Volt_Unbalance_Fault
37	AC_Curr_Unbalance_Fault
38	INV_A_OCP_Fault
39	INV_B_OCP_Fault
40	INV_C_OCP_Fault
41	AC_WU_OverVolt_Fault

No.	Description
42	AC_WU_UnderVolt_Fault
43	AC_VW_OverVolt_Fault
44	AC_VW_UnderVolt_Fault
45	AC_UV_OverVolt_Fault
46	AC_UV_UnderVolt_Fault
47	AC_OverFreq_Fault
48	AC_UnderFreq_Fault
49	AC_GridCurr_DcHigh_Fault
50	PV1_CurrHigh_Fault
51	PV2_CurrHigh_Fault
52	AC_GridCurr_High_Fault
53	AC_L1Curr_High_Fault
54	AC_L1CurrDc_High_Fault
55	AC_Overload_Fault
56	AC_Lightload_Fault
57	BAT_OverTemp_Fault
58	Smake_alarm_Fault
59	AC_OverTemp_Fault
60	DC_OverTemp_Fault
61	AC_BypassOverPower_Fault
62	AC_U_BypassOverPower_Fault

No.	Description
63	AC_V_BypassOverPower_Fault
64	AC_W_BypassOverPower_Fault
65	EPO_Stop
66	KeyEmergencyStop
67	LcdEmergencyStop
68	NO_Bat_Fault
69	BAT_MainContactor_Fault
70	AC_U_Overload_Fault
71	AC_V_Overload_Fault
72	AC_W_Overload_Fault
73	GFDI_Ground_Fault
74	AC_Contactor_Fault
75	GFDI_AirSwitch_Fault
76	PV_Thunder_Fault
77	AC_Thunder_Fault
78	BAT_Thunder_Fault
79	BusVolt_Unbalance_Fault
80	INT_PV3_OverCurr_Fault
81	DC_GFDI_Fault
82	BMS_Warning

Table 6.3.1 General history failure table

### 6.3.2 Severe history failure table

No.	Description
1	PV_Reseverd_Failure
2	IGBT_Failure
3	EEPROM_Write_Failure
4	EEPROM_Read_Failure
5	AC_MainContactor_Failure
6	AC_SlaveContactor_Failure
7	GFDI_Failure
8	GFCI_Failure
9	RISO_Failure
10	BAT_MainContactor_Failure
11	AC_BypassOverPower_Failure
12	AC_U_BypassOverPower_Failure
13	AC_V_BypassOverPower_Failure
14	AC_W_BypassOverPower_Failure
15	BAT_Reseverd_Failure
16	Reseverd_Failure

Table 6.3.2 Severe history failure table

### 6.3.3 Inverter status

No.	Description
0	wait
1	check
2	Grid mode
3	malfunction
4	Permanent failure
5	Off-grid mode

## 7 Routine Maintenance

### 7.1 Fan Maintenance

To ensure that the inverter works normally, you need to clean the air filter regularly. When the inverter is working in a high temperature environment, good ventilation and heat dissipation can effectively reduce the probability of load shedding. The inverter is equipped with a cooling fan. When the internal temperature of the inverter is high, the fan works to reduce the internal temperature. If the inverter is low in output due to excessive temperature, the following are possible causes and countermeasures.

- The fan is clogged and the fan and fan cover need to be cleaned.
- The fan is damaged and the fan needs to be replaced.
- Inverter installation location is poorly ventilated, and the appropriate installation location should be selected according to basic installation requirements



Warning:

Do not use a gas pump to clean the fan, as this may cause damage to the fan.

#### Fan cleaning or replacement:

1. Before cleaning or replacing the fan, please make sure that the DC side and AC side of the inverter have been disconnected.

- Turn off the DC side switch.
- Unplug the DC input terminal (user needs to use a tool to disconnect the DC connection).
- Disconnect the AC open.

2. Rotate the screw counterclockwise with an M4 Phillips screwdriver.

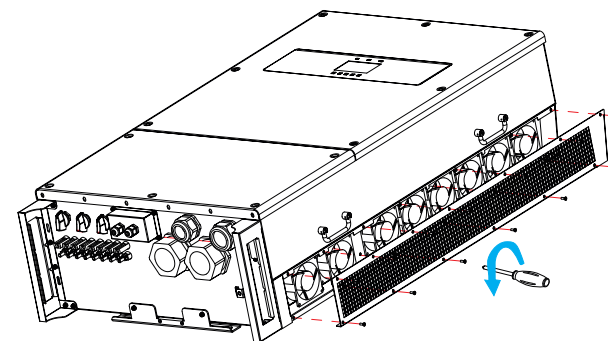

3. Disconnect the fan connector and remove the fan as shown below.

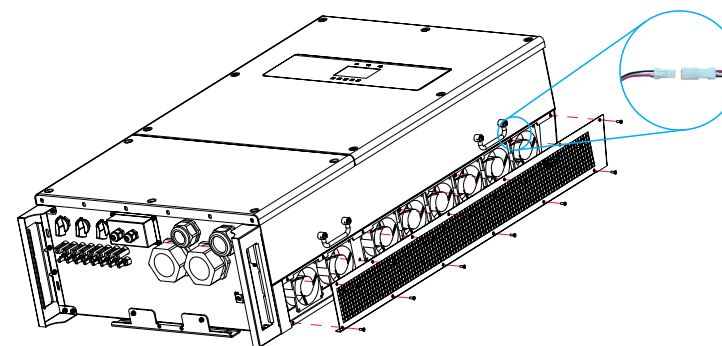

4. Clean the fan and steel mesh or replace the fan

Cleaning fan and steel mesh

- Clean the fan and steel mesh with a gas pump or other tools.
- Remove each fan separately for cleaning if necessary. Replace the fan
- Use a Phillips screwdriver to remove the fan that needs to be replaced.
- Replace the brand new fan, arrange the wire harness and fix it with a cable tie.

5. Reinstall the fan mounting plate and inverter.

## 7.2 Regular maintenance

Maintenance item	Period
Read data from the datalogger	Monthly
Check if the cable connection is loose	Monthly
Manual inspection of AC and DC circuit breakers	Monthly
LCD stop function	Monthly
Check if there is abnormal noise during the running of the machine	Weekly
Check battery components for abnormalities, swelling, smoke	Daily



The energy storage controller must be regularly maintained to ensure its normal operation and service life.

The recommended routine maintenance cycle and work contents are shown in Table 7-2.

## 7.3 Waste treatment

The energy storage controller will not pollute the environment, and the constituent materials and components of the product will meet the environmental protection requirements. ATESS shall, according to environmental protection requirements, be treated according to local regulations when the energy storage controller is used.

## 8.1 Specification

Model	ATESS HPS50000TL-US-208A
Dimension (W/H/D)	655x1155x300mm
Weight	124kg
Environment temperature	-25 °C... +55 °C
Protection degree	IP65/Type 3R
Standby consumption	<45W
Cooling	Forced-air
Noise emission	<65dB(A)@1m
Display	Touch screen
Communication interface	RS485/CAN/WIFI/4G

## 8.2 Warranty

### Warranty period

The warranty period of this product is one year. If otherwise specified in the contract, the contract shall prevail.

During the warranty period, the customer shall show the invoice and date of purchase to the service personnel of ATESS. At the same time, the nameplate mark on the product shall be clear and visible, otherwise, ATESS has the right not to provide warranty service.

### Warranty condition

In the event of failure during the warranty period, ATESS will repair or replace the product free of charge, The customer shall Set aside some time to repair the faulty machine.

### Liability exemption

In case of the following circumstances, ATESS has the right not to conduct warranty:

1. Products without logo of ATESS Power Technology logo.
2. The product or component that has exceeded the valid warranty period of ATESS.
3. Failure or damage (such as high temperature, low temperature, too wet or dry, high altitude, unstable voltage or current, etc, )caused by working in beyond-specified environment or wrong installation storage or use that violates the instructions.
4. Failure or damage caused by unauthorized installation, repair, modification or disassembly. except for those authorized by ATESS.
5. Failure or damage caused by using components that not supplied by ATESS.
6. Failure, damage or transportation damage caused by accident or human factors (operation error,scratching, carrying, bumping, improper voltage connection etc.).
7. Failure or damage caused by force majeure (such as earthquake, lightning, fire etc.).
8. Failures or damages caused by other factors rather than quality problems of the supplied product itself(including components).

### DANGER:

Risk Of Electric Shock. Both ac and dc voltage sources are terminated inside this equipment. All circuits must be individually disconnected before servicing.

When the photovoltaic array is exposed to light, it supplies a dc voltage to this equipment.

**CAUTION:** Risk of Electric Shock, Do Not Remove Cover. No User Serviceable Parts Inside. Refer Servicing To Qualified Service Personnel.

WARNING - For Continued Protection Against Risk Of Fire, Replace Only With Same Type And Ratings Of Fuse.

Do not remove cover until 5 minutes after disconnecting all sources of supply.

Hot surfaces - To reduce the risk of burns - Do not touch.

### DANGER:

Risque de choc électrique. Les sources de tension ac et dc sont terminées à l'intérieur de cet équipement. Tous les circuits doivent être déconnectés individuellement avant l'entretien.

Lorsque les panneaux photovoltaïques sont exposés à la lumière, ils fournissent une tension continue à cet équipement.

**Attention:** Risque de choc électrique, ne pas enlever le couvercle. Pas de pièces utilisables à l'intérieur. Référez l'entretien à du Personnel de Service qualifié.

Avertissement - pour une Protection continue contre le risque d'incendie, remplacer seulement par le même Type et les cotes de fusible.

Ne retirez le couvercle que 5 minutes après avoir débranché toutes les sources d'alimentation.

Surfaces chaudes - pour réduire le risque de brûlures - ne pas toucher.