

**SHENZHEN ATESS POWER TECHNOLOGY CO.,LTD**

GROWATT-ATESS Industrial Park, No.23 Zhulongtian Road, Shuitian Community,  
Shiyan Street, Baoan District, Shenzhen

Tel: +86 755 2998 8492

Web: [www.atesspower.com](http://www.atesspower.com)

Email: [info@atesspower.com](mailto:info@atesspower.com)

Revised date: 2026-06-16

**ATESS PCS1000HV/1200HV/1500HV**

Bidirectional battery Inverter  
User Manual

# Contents

## 1 About this Manual

- 1.1 Contents
- 1.2 Target readers
- 1.3 Symbols explanation

## 2 Safety Instructions

- 2.1 Instructions
- 2.2 Installation
- 2.3 Important notes

## 3 Product Description

- 3.1 Bi-directional Storage system
- 3.2 Circuit diagram of the inverter
- 3.3 The layout of the main components
- 3.4 Operation mode
- 3.5 Dimensions and weight
- 3.6 Packaging information

## 4 Transportation and Storage

- 4.1 Transportation
- 4.2 Inspection and storage

## 5 Installation

- 5.1 Installation condition requirements
- 5.2 Tools and spare parts required for whole machine installation
- 5.3 Mechanical installation
- 5.4 Electrical installation
- 5.5 Communication
- 5.6 Connection with DG dry contact
- 5.7 Connect with communication

## 6 Pilot Operation

- 6.1 Inspection
- 6.2 Power on

## 7 GUI instruction

- 7.1 LCD display screen introduction
- 7.2 LCD operation
- 7.3 LCD display information schedule
- 7.4 General troubleshooting

## 8 Operation

- 8.1 Power on steps
- 8.2 Pilot operation completion
- 8.3 Power off steps

## 9 Routine Maintenance

- 9.1 Regular maintenance
- 9.2 Waste disposal

## 10 Appendix

- 10.1 Specification
- 10.2 Inductive Load Conditions
- 10.3 ATESS Factory warranty
- 10.4 Maintenance and inspection checklist for running system
- 10.5 Maintenance and inspection checklist for shutdown system

# 1 Introduction

## 1.1 Contents

This manual will provide detailed product information and installation instructions for users of the ATESS PCS series energy storage integrated inverter (hereinafter referred to as inverter) of Shenzhen ATESS power Technology Co., Ltd. (hereinafter referred to as ATESS). Please read this manual carefully before using the product and store it in a place convenient for installation, operation and maintenance. Users will not be informed of any modification of this manual by ATESS. The contents of the manual will be updated and revised constantly, and it is inevitable that there is a slight discrepancy or error between the manual and the real product, Please refer to the actual products that you have purchased. Users should contact their local distributors or log in to our website: [www.atesspower.com](http://www.atesspower.com) to download and obtain the latest version of the manual.

## 1.2 Target readers







### Qualification:

- Only professional electricians certified by relevant departments can install this product.
- The operator should be fully familiar with the structure and working principle of the entire energy storage system.
- The operator should be fully familiar with this manual.

The operator should be fully familiar with the local standards of the project.

## 1.3 Symbols

In order to ensure the personal and property safety of the user during installation, or optimally efficient use of this product, symbols are used highlight the information. The following symbols may be used in this manual, please read carefully, in order to make better use of this manual.

	<p><b>DANGER</b> DANGER indicates a hazard with a high level of risk which, if not avoided, will result in death or serious injury.</p>
	<p><b>CAUTION</b> CAUTION indicates there is potential risk, if not avoided, could result in equipment malfunction and property damage.</p>
	<p><b>Caution, risk of electric shock</b> When battery bank connecting point are exposed, there will be DC voltage in the equipment DC side; and when output breaker is on, there is a potential risk of electric shock.</p>
	<p><b>Caution, risk of fire hazard</b> Suitable for mounting on concrete or other non-combustible surface only.</p>
	<p><b>Protective conductor terminal</b> The inverter has to be firmly grounded to ensure the safety of personnel.</p>
	<p>Risk of electric shock, Energy storage timed discharge Electrical shock danger exists in the capacitor; the cover shall be moved at least 5 minutes later after all powers are disconnected.</p>

## 2 Safety Instructions

### 2.1 Notice for use

Inverter installation and service personnel must be trained and familiar with the general safety requirement when working on electrical equipment. Installation and service personnel should also be familiar with the local laws and regulations and safety requirements.

- Read this manual carefully before operation. The equipment will not be under warranty if failing to operate according to this manual.
- Operation on the inverter must be for qualified electrical technician only.
- When inverter operating, don't touch any electrical parts except for the touch-screen.
- All electrical operation must comply with local electrical operation standards.
- Permission from the local utility company is required before installing the energy storage system and only professional personnel are qualified for the operation.

### 2.2 Installation

Proper installation requires following all the instructions in the user manual involving transportation, mounting, wiring and commissioning. ATESS does not cover warranty for the inverter damage due to failing to use it properly.

The protection level of the inverter is IP20, which is designed for indoor installation.

Please refer to chapter 5 for installation instruction.

Other notice for using the inverter:

- Pay attention to the safety instructions listed here and below
- Pay attention to the user manual of energy storage controller
- Technical data related to equipment shall be considered.

### 2.3 Important note



Item 1: Static electricity can cause damage to the inverter electrostatic discharge may cause unrecoverable damage to inverter internal components!

When operating the inverter, operator must comply with anti-static protection norms!

Item 2: Restriction

The inverter cannot be directly used to connect the life support equipment and medical equipment!

Item 3: Precautions

Make sure installation tools or other unnecessary items are not left inside the inverter before starting up.

Item 4: Maintenance notice

Maintenance can only be carried out after the inverter totally discharged.

## Product Description 3

### 3.1 Bi-directional energy storage inverter

1. PCS series energy storage controller produced by ATESS is a bidirectional battery inverter. Its main function is to store the energy of power grid to the battery, or release the stored energy to the power grid or supply load.

2. At the same time, it can be combined with solar charge controller to charge photovoltaic energy into the battery or output it through inverter of energy storage controller.

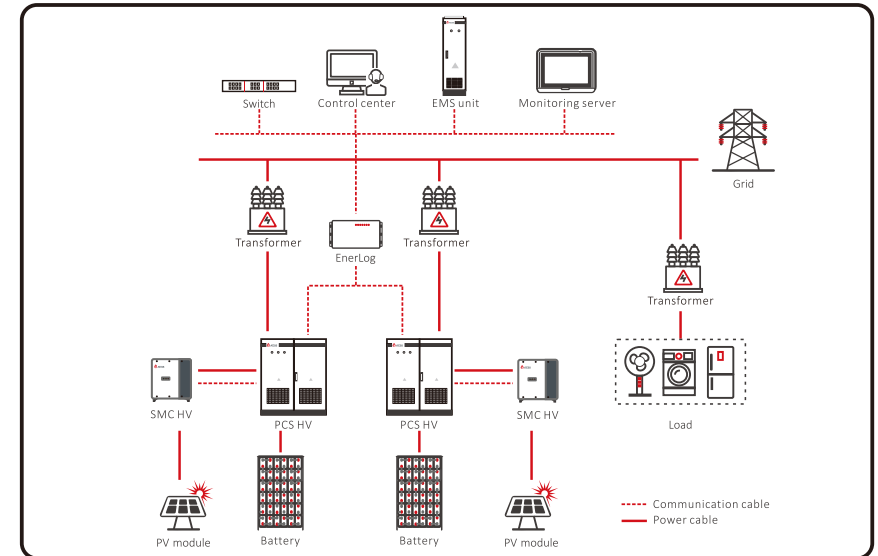

SMC HV + PCS HV system diagram

#### System Description:

**SMC HV:** Photovoltaic DC converter, photovoltaic DC input, and then DC output to charge the battery, or inverter output through the energy storage controller to supply load or power grid.

### 3.2 Circuit diagram of the inverter

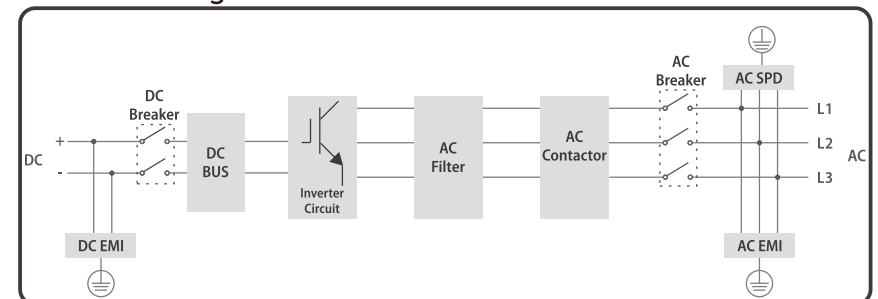

### 3.3 The layout of the main components

#### 3.3.1 External components

The main external components of the energy storage controller include: LED indicator, LCD touch screen, off-on knob, emergency stop button and other parts.

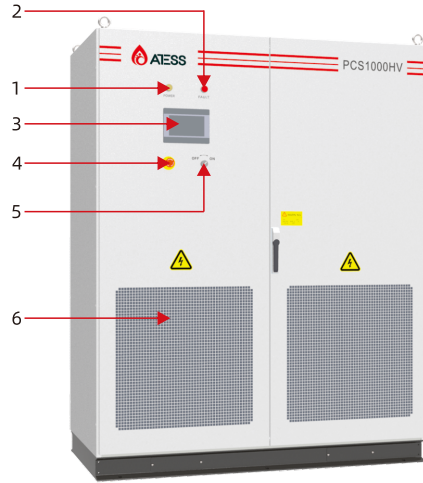

Figure 3-3-1-1 Inverter appearance

No.	Name	Description
1	Power indicator	When power supply is normal, the indicator displays yellow.
2	Inverter malfunction indicator	When inverter is faulty, the indicator displays red.
3	Touch Screen LCD	Operation information display, receive control command and parameters setting
4	Emergency STOP	Shut down the inverter when pressed down
5	Off-on knob	Only control the grid-side switch, and does not control the DC-side switch
6	Dust screen	Prevent dust from entering into the inverter

Figure 3-3-1 Part description

#### Indicator

There are two LED indicators on the inverter which is used to display the current status of the inverter.



Figure 3-3-1-2 LED indicators

#### Emergency STOP



The emergency stop button is only used in case of emergency, such as: serious failure in the grid, fire, etc.



Figure 3-3-1-3 Emergency STOP

The emergency stop button immediately disconnects the inverter from both grid and battery, which ensure the safety of the inverter. By pressing the emergency stop button, the device will be locked in the "off" position. Only release the emergency stop button by rotating it clockwise and closing AC, DC breaker, can the inverter resume working normally.

#### Off-on knob

It is used to start or stop the inverter.



Figure 3-3-1-4 Off-on knob

#### Touch screen

It displays the inverter's operating parameters, power generation, and faulty information record. Please refer to Section 6, for details.

#### 3.3.2 Components at the front

The main components of PCB and AC power supply circuit breaker include lightning protection switch, AC power supply circuit breaker, etc. The layout of different models is different, not all of them can be displayed here, which does not mean that there is no such part.

### 3.3.2.1 PCS1000HV/1200HV/1500HV main parts overview

NO	Name	Description
1	Capacitance	DC bus capacitance
2	IGBT module	IGBT module Power module
3	Sampling board	PCB that samples voltage, current and temperature
4	IO and Control board	Control board and Power supply
5	Connect board	PCB that Component port control
6	DC fan	Heat dissipation
7	AC fan	IGBT module heat dissipation
8	DC main relay	DC main relay
9	Battery circuit breaker	Control the connection of battery and PCS
10	AC/DC power supply microbreake	AC/DC power supply micro breaker
11	Rectifying board	DC power supply and AC/DC power supply PCB
12	BUCK board	DC Power supply PCB
13	Mingwei power	Power supply module
14	AC circuit breaker	Control AC connection with PCS
15	Power frequency transformer	Power extraction from this transformer and fan power supply
16	Terminal block	Terminal block connecting with bypass cabinet
17	AC lightning protection and lightning protection switch	AC lightning protection and lightning protection switch
18	PE terminal	Grounding copper bar

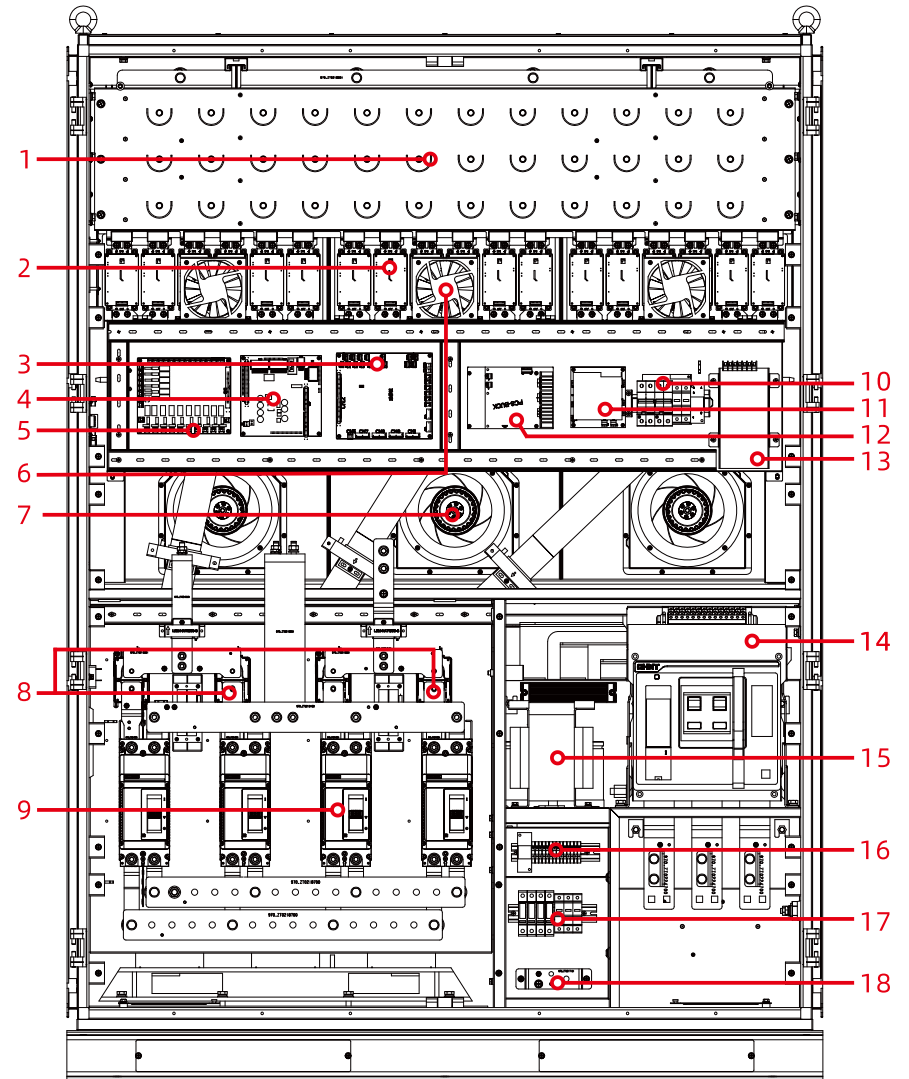

PCS1000HV/1200HV/1500HV main parts overview

### 3.4. Operation mode

1. Please read chapter 7.2.4 for the setting method of operation mode, and set the operation mode on the screen.

2. PCS HV is generally connected to the grid through a step-up transformer and operates in on-grid mode. When the grid get off, PCS HV can operate off-grid through black start.

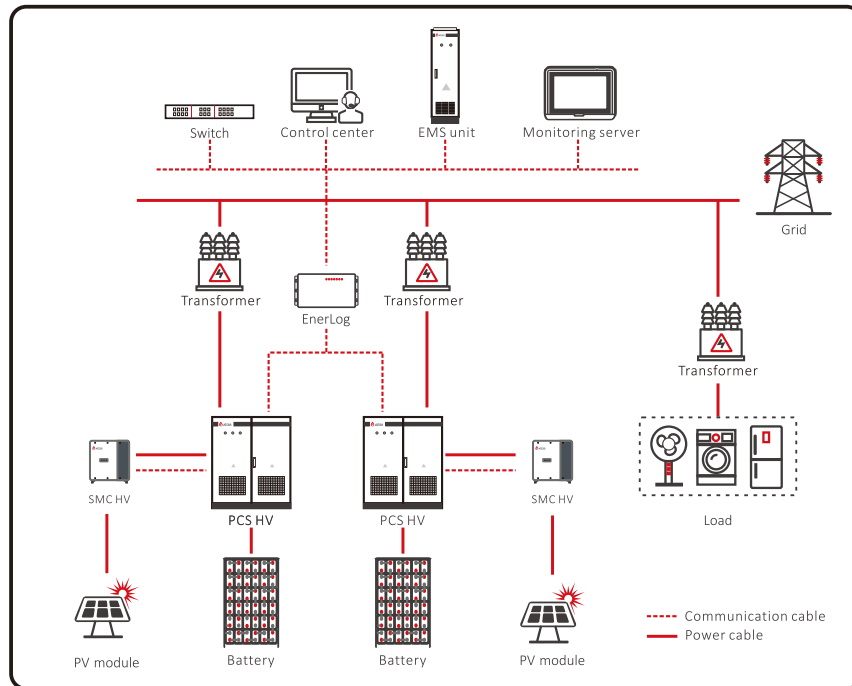

System diagram

#### 3.4.1 On-grid mode

The PCS is designed with perfect on-grid operation function and can flexibly adapt to different batteries to control charging and discharging. Charging/discharging mode and charging/discharging instruction are set through the EMS or on the user interface.

The on-grid operation mode can well adapt to scenarios such as peak shaving, frequency regulation, peak load shifting, smooth grid connection of new energy, and the like.

##### 3.4.1.1 Time shifting mode

1. Peak period: There are five time periods on the screen, and the corresponding discharge power value (KW) can be set for each time period. When reaches the set time, it will discharge automatically based on the set value.

2. Fair period: the screen can be set for 5 time periods, and the battery will not be charged or discharged during the set time period.

3. Valley period: the screen can be set for 5 periods, and the corresponding charging power value (KW) can be set for each period. When reaches the set time, it will discharge automatically based on the set value.

4. Time segments cannot overlap or be omitted.

5. For details about how to set a time range, see 7.2.4.

#### 3.4.1.2 EMS mode

Description:

1. In EMS mode, the PCS is controlled by EMS management system and has no operation logic itself, and the power is controlled by EMS command;

2. The power transmitted under EMS mode is still limited by the screen setting value;

3. It needs to be used with EMS;

#### 3.4.2 Off-grid mode

The PCS can implement black start in the off-grid state through the independent inversion function (VF), and can provide AC voltage source with stable voltage amplitude and frequency to support the load. Independent inversion voltage instruction and frequency instruction are set through the EMS or on user interface.

The independent inversion function can provide power supply to keep the system stable in remote area, island, commercial micro grid, and other scenarios. In addition, the PCS can be used as a standby power source to ensure power supply on important occasions or for important device.

#### 3.4.3 Fault mode

When the inverter fails, the contactor on AC and DC sides will immediately disconnect and shut down the inverter, so as to ensure the system safety. At this time, the inverter will continuously monitor whether the fault is eliminated, if not, it will maintain the fault state; after eliminated, it will restart automatically.

#### 3.4.4 Permanent failure mode

When the inverter has a serious fault, the contactor on AC and DC sides will immediately disconnect and enter a permanent fault state to ensure safety of the system. When permanent fault is detected three times in a row, all switches will be disconnected. For example, the IGBT module of the inverter is faulty. When inverter enters this permanent failure mode, please do not repair it without permission. You should contact the personnel of the local dealer or call ATESS for help.

## 3.5 Dimensions and weight

Model	PCS1000HV	PCS1200HV	PCS1500HV
Dimension(W*H*Dmm)	1510/2100/890mm		
Weight(KG)	1524		

Figure--Net Dimensions and weight of PCS

## 3.7 Packing information

NO	Name	Unit	Qty.	Note
1	PCS	unit	1	Key included
2	User manual	pcs	1	
3	Certificate	pcs	1	
4	Factory test report	pcs	1	
5	Accessories	pcs	1	Communication lines etc.

Figure--Packing information

## 4.1 Transportation

Transportation should follow the transportation methods described in the user manual. The inverter's weight and center of gravity should be taken into account



### Caution, risk of danger

During transportation, lifting equipment and personnel must be qualified. The inverter should be placed vertically and the inclination cannot be more than 10 degrees. It is not allowed to place the inverter upside down or transport in a horizontal position. Incorrect lifting and transportation can lead to serious injury, property loss and damage to the inverter.

## 4.2 Inspection and storage

The inverter should be carefully checked before signing the document from the transportation company. Check the received items against delivery note, and if there is any defect or damage, immediately notify the transportation company. If necessary, you can seek help from ATESS Customer Service department.



### Caution

ATESS PCS can only be stored when it is stopped and all the doors are closed in a dry room to protect the internal circuits against dust and moisture.

# 5 Installation

## 5.1 Installation condition requirements

To ensure normal operation of the machine, the installation environment is required as follows:

- The ingress protection of inverter is IP20. Moreover, as this product is an electronic equipment, it shall not be placed in humid environment.
- Install indoors and avoid sunlight and rain.
- Ventilation of the room shall be good.
- The installation environment shall be clean.
- As some noise will be produced in operation, this equipment shall be installed far from residential quarters.
- The installation ground shall be even enough, and firm enough to support the weight of inverter.
- The installation position shall be convenient for maintenance.
- Ambient temperature range: -25°C~55°C.
- Appropriate space shall be reserved for the machine to ensure ventilation and cooling.

We suggest inverter is installed in the distribution room. The floor, wall clearance, Ventilation equipment and precaution should be designed by professional personnel and satisfy the following requirements.

### ● Foundation requirement

Inverter is required to install on even ground with fire-retardant material as the surface or channel steel support structure, and sag or tilt ground is prohibited. The foundation shall be solid, safe and reliable. The foundation shall be capable of bearing the load of the inverter. Its load bearing ability shall be concerned throughout the installation place selection.

### ● Clearance space

During installation of the inverter, appropriate space shall be left to the wall or other equipment, in order to satisfy the requirements on narrowest maintenance channel, emergency access and ventilation.

In front of the installation place of inverter, a space of 0.8m or more shall be ensured, the back 0.8m or more, the top 0.8m or more to ensure easy installation, cooling and maintenance.

### ● Cable trench

The cable connection of inverter adopts bottom inlet and bottom outlet. Cable trenches are recommended to ensure easy installation and maintenance.

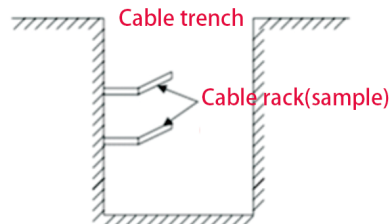

The cable trenches are often designed and constructed by the construction side based on relevant standards, with the equipment weight and dimensions required to be considered. Good electrical connection is needed between different cable trenches and GND terminals.

### ● Wiring specification

Cables in the inverter can be classified into either power cables or data cables. In cabling, the power cable shall be kept far away from, and the cable shall be kept in right angle at cross. The cable shall be as short as possible, and an appropriate distance shall be kept to the power cable. It is recommended that the insulation impedance of BT + and BT - at DC end to ground to be higher than 1m.

The power cable and data access shall be placed in different cable trenches respectively to avoid lengthy routing between the power cable and other cables, so as to reduce the electromagnetic interruption caused by sudden change of the output voltage. The distance among the power cable and data access shall be more than 0.2m. When the cables are crossed, the cross angle shall be 90 degrees, while the distance can be reduced appropriately.

### ● Ventilation requirement

In operation, inverter will produce a lot of heat. When ambient temperature is too high, the electrical property of the equipment may be affected, the equipment may even be damaged. Therefore, the heat release shall be fully considered in designing the control room to ensure operation of the equipment in high efficiency.

### ● Ventilation environment

To satisfy the ventilation requirement of inverter, its installation environment shall meet the following conditions:

- ※ Inverter shall be prevented from being installed in the place of poor ventilation condition and insufficient air flow;
- ※ The air inlet shall have enough air supplementation.

### ● Ventilation equipment

To ensure safe and reliable operation of the equipment, the ambient temperature must be within the permission range -25°C~ 55°C, therefore, appropriate ventilation devices must be equipped with to release the heat generated by the equipment.

1. There must be ventilation equipment inside the distribution room to ensure release of the waste heat generated by the inverter from the equipment, and allow for maximum ambient environment temperature. This can be realized from installation of exhaust devices;
2. Another fan can be added at the air duct outlet to exhaust the air out and ensure balanced pressure;
3. The direction of the air outlet shall be selected according to the local actual wind direction;
4. Pay attention to the dustproof measures and waterproof design at the air inlet and outlet;
5. If more air ducts are required, its dimensions shall be designed by the professionals according to the air output amount.

### ● Other protections

With IP20 of protection level, inverter is appropriate to be installed in dry and clean environment. Meanwhile, water leakage of the house shall be prevented, as it may damage the inverter. According to EMC requirement and noise level, the inverter shall be installed in industrial environment.

## 5.2 Tools and spare parts required for whole machine installation

Tools and spare parts required for installation is as follows:

Hoisting crane, forklift or fork lift truck (with the capacity for bearing the weight of the inverter)

- Torque wrench
- Screwdriver
- Wire stripper
- Terminal crimping machine
- Heat dryer
- Megger and multimeter

## 5.3 Mechanical installation

### 5.3.1 Transportation of packaged whole machine

This inverter is transported as an integrated unit, and the user can hoist it from the bottom with a forklift, or move it with a hoisting crane or crane.

**Note 1:** The inverter is integrated and cannot be dissembled either in transportation or installation. Any fault attributed to modification unauthorized by the ATESS is beyond the quality assurance.

**Note 2:** In movement, tilt, violent shake or sudden force upon the inverter shall be prevented, such as sudden down of lifting.

**Note 3:** Please read carefully the labeled parameters to select an appropriate transportation means and storage place.

We suggest the user make use of forklift to move the inverter if possible.



Before the inverter is moved to the designated place, we suggest to lay the DC input cable and AC main power supply cable. As these cables are relatively thick, they are hard to be cabled after the inverter is installed.

To keep the equipment in a better protective status, please adopt transportation with package as much as possible, and comply with the labels printed on the package in transportation:

Sign	Indication
	The gravity centre
	Lifting logo
	Face up to prohibit the inverter horizontally, tilted or upside down
	Handle with care, to avoid the transport environment too intense collision friction damage to the inverter
	Keep away from moisture

Inverters whose packages are not demolished can be moved with forklift, hoisting crane or crane. In moving, attention shall be paid to the weight painted on the package to ensure enough load capacity of the devices. As the gravity center of the equipment locates at the lower place symmetrical in front and back and left and right, the support point or hoisting point shall be arranged reasonably in transportation.

The forklift transportation is the standard one. The gravity center of the cabinet in transportation should locate between two forks of the forklift. The big-size inverter may block driver's sight, and it shall be treated with cooperation of the aid personnel.

### 5.3.2 Movement and installation of bare machine

#### ● Demolish the package of inverter

Please demolish the packaged cabinet of the equipment according to the following procedures:

Procedure 1: Demolish the wood side and roof of the packaged cabinet

Procedure 2: Demolish the out-set package material on the machine

Procedure 3: Demolish the fastening screws between the machine and the pallet

- ① Demolish the front and back cover lids of the pedestal.
- ② Screw off the hold-down nuts at the bottom of the wood pallet.
- ③ Remove the screws, and the inverter will depart from the wood pallet.

#### ● Movement and installation of bear machine

The inverter with demolished package can be moved with forklift, hoisting crane, slide rail or crane. If the package demolished place is far from the final installation place, it can be transported with forklift containing wood pallet.

If the wooden pallet at the bottom of the machine has been removed, when using the forklift, the front and rear cover plates of the base need to be removed first, and the center of gravity should be placed in the middle of the two forklifts, and then start lifting and transporting, as shown in the following figure:

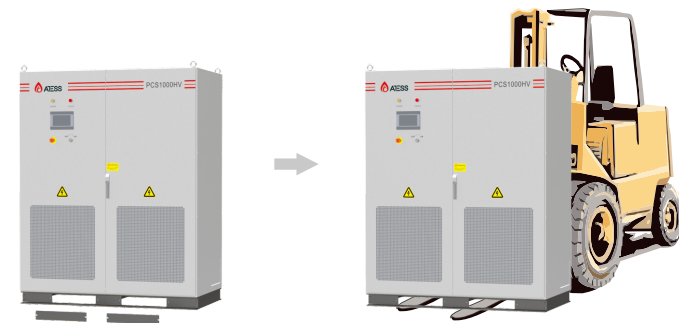

#### Caution, risk of danger

We must act slowly and gently when transporting the inverter with forklift to avoid violent vibration of the inverter or collision with other objects.

If lifting method is used for moving, please pay attention to the lifting position, ensure that the lifting angle is 70°, and be cautious of the center of gravity position of the inverter.

**NOTE:**

- It is necessary to always pay attention to the position of the center of gravity of inverter.
- Take necessary auxiliary measures to ensure the safety of transportation personnel
- Take necessary auxiliary measures to ensure that the equipment is delivered to the final installation site.

## 5.4 Electrical installation

### 5.4.1 Input and output requirements



**Caution, risk of danger**

- There is a danger of electrical shock of high voltage in inverter's operation; only electricians of professional skills can operate.
- All connections with this equipment shall be done under non-voltage state.
- The inverter may be damaged if input or output terminal is incorrectly plugged. Failure of acting upon this information may cause serious personnel injury or significant property loss even to death.

● **Battery**

The PCS1000HV battery operating voltage is 900V- 1500V. The battery voltage should be not lower than 900V and not higher than 1500V; PCS1200HV battery operating voltage is 900V- 1500V. The battery voltage should be not lower than 900V and not higher than 1500V;; PCS1500HV battery operating voltage is 1000V-1500V,The battery voltage should be not Lower than 1000V and not higher than 1500V.

● **Three phase grid connection**

The inverter will constantly detect whether the power grid meets the grid connection conditions. The grid connection requirements of various countries may be different. The protection parameters of the inverter can be set. For details, please refer to the local grid connection regulations. The power grid is a three-phase power grid. Plus, the installation shall be approved by the local power department.

Model	PCS1000HV	PCS1200HV	PCS1500HV
Grid voltage limit	360V-440V	495V-605V	621V-759V
Grid frequency limit	45Hz-55Hz/55Hz-65Hz		

● **Cable requirements**

1. Please select the corresponding withstand voltage cable according to the voltage level.
2. Because different voltage will lead to change of current, please calculate the corresponding cable diameter according to the actual voltage range. The following table only provides the cable requirements of the lowest working voltage and rated power. In actual application, it should be calculated according to the actual voltage, please inquire the after-sales staff of ATESS if you need more details.
3. The PCS1000HV's isolation transformer is externally mounted and internally wired. Connect 4 x 120mm<sup>2</sup> wires below the reactor. Connect 4 x 150mm<sup>2</sup> wires to the AC contactor. Connect a 4mm<sup>2</sup>~10mm<sup>2</sup> wire from the transformer's neutral (N) terminal to the PCS1000HV's neutral (N) terminal. PCS1200HV and PCS1500HV use external transformers. Only the cables in the table below are needed.

The cables should be calculated according to the actual voltage, or you could contact ATESS.

Cable	Requirements for bus diameter					
	PCS1000HV		PCS1200HV		PCS1500HV	
Model	Diameter	Aperture	Diameter	Aperture	Diameter	Aperture
<b>Battery</b>	120mm <sup>2</sup>	Φ12	150mm <sup>2</sup>	Φ12	150mm <sup>2</sup>	Φ12
<b>AC output</b>	150mm <sup>2</sup>	Φ12	150mm <sup>2</sup>	Φ12	150mm <sup>2</sup>	Φ12
<b>N line</b>	150mm <sup>2</sup>	Φ12	150mm <sup>2</sup>	Φ12	150mm <sup>2</sup>	Φ12
<b>Ground line</b>	The cross-sectional area of the ground cable should not be less than half of the cross-sectional area of the AC output cable					
<b>Communication line</b>	Shielding wire: ≥0.75mm					

### 5.4.2 DC side wiring



#### Caution, risk of danger

The positive and negative of the battery shall not be connected in reverse. A multimeter shall be used to determine the polarity first, and then connect into the corresponding input ends of the battery.

Specific procedures are as follows:

- 1) Cut off the distribution circuit breaker at the DC side, and ensure that no voltage on the wire at DC side.
- 2) Use a multimeter to measure the open circuit voltage of the battery to ensure that it is within the allowed range.
- 3) Determine the positive and negative pole of the battery with a multimeter.
- 4) Strip off the insulation skin at the end of the cable.
- 5) Crimp the wiring copper nose.
  1. Put the stripped copper core into the crimping hole of the copper nose.
  2. Use the terminal pressing machine to press the copper nose tightly. The number of crimping shall be more than two.
- 6) install the shrink fit sleeve.
  1. Select the heat shrinkable sleeve which is more consistent with the cable size, length is about 5cm.
  2. The heat shrinkable sleeve shall be sleeved on the copper nose of the wiring to completely cover the wire pressing hole of the copper nose.
  3. Use a heat blower to tighten the heat shrink sleeve.
- 7) Connect the positive of the battery to the "Battery input +" of DC input.
  1. Select the bolts that match the copper nose.
  2. Connect the copper nose at both ends of the wiring firmly to the "battery input +" end of the inverter and the positive pole of the battery.
  3. Tighten the bolts with a screwdriver or wrench.
- 8) Connect the "battery input -" end of the inverter to the negative pole of the battery by cable according to the method of step 7.
- 9) Please be sure that all wiring are fastened.

### 5.4.3 AC side wiring



#### Caution, risk of danger

When connecting the AC grid, cut off the circuit breaker at the AC side to ensure that the AC wire connecting to terminals has no electricity.

The AC side output voltage of PCS1000HV is 400V, the AC side output voltage of PCS1200HV is 550V, and the AC side output voltage of PCS1500HV is 690V. The wiring method of AC side and grid side is as follows:

- 1) Cut off the circuit breaker at AC side, to ensure that the AC wire connecting to terminals has no electricity. Confirm it with a multimeter.
- 2) Ensure that the wiring phase sequence at AC side is in consistent with the phase sequence at grid side.
- 3) Strip the insulation skin off at the end of the cable
- 4) Crimping copper nose
  1. Put the exposed copper core of the stripped wire head into the crimping hole of the copper nose.
  2. Use the terminal crimper to compress the copper nose of the wiring, and the number of crimping shall be more than two.
- 5) Install the shrink fit sleeve.
  1. Select the heat shrinkable sleeve which is more consistent with the cable size, length is about 5cm.
  2. The heat shrinkable sleeve shall be sleeved on the copper nose of the wiring to completely cover the wire pressing hole of the copper nose.
  3. Use a heat blower to tighten the heat shrink sleeve.
- 6) Connect "L1" cable to "L1" terminal on grid breaker or "L1" on PCS breaker of bypass cabinet. Select the bolts that match the copper nose.
- 7) Connect the AC output "L2" to the power grid switch "L2" or the PCS switch "L2" on the bypass cabinet (B (V) phase) as described in Step 6. Connect "L3" of AC output to power grid switch "L3" or PCS switch "L3" of bypass cabinet, namely C (W) phase; Connect N wire to the N bar on PCS. (The PCS500/630 transformer needs to be external, so there is no N bar inside the PCS, so connect the N of the transformer directly to the N bar of the bypass cabinet).

### 5.4.4 Earthing

Inverter must be earthing well for safety; Please make sure of the connection between PE in power distribution cabinet and PE copper in the inverter good; and make sure the earthing cable more than half of load cable, and earthing resistance is not lower than 4Ω.

All wiring into the channel at the bottom of the inverter to be all the wiring is completed, the connection port must be sealed with dust cotton, to prevent dust from entering the inside of the inverter.



Connect several connecting wires on the PE copper bar as some parts inside the energy storage controller need to be grounded, please do not change them without permission, so as to avoid electric shock

## 5.5 Communication

The PCS adopts various communication modes. The figure below is the diagram of the communication port of the control board on PCS1000.

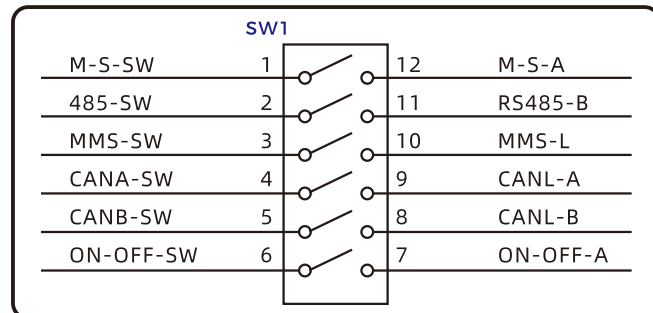
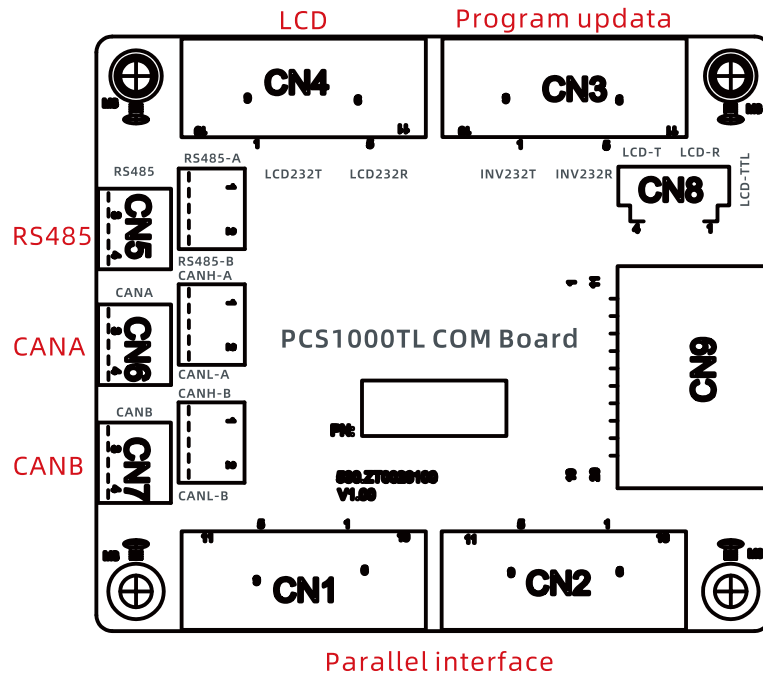

The DIP switch/DHN-06SM

No.	Name	Description
1	M-S	Parallel matching resistance
2	485	485 matching resistance
3	MMS	Parallel matching resistance
4	CANA	CANA matching resistance
5	CANB	CANB matching resistance
6	ON-OFF	Parallel matching resistance

### 1. RS485 communication

- Multiple inverters communicate with each other through RS485 line, and finally transmitted to the monitoring server through the Shinemaster / Enerlog via Ethernet, which can remotely monitor the operation status and data of single / multiple inverter(s) in real time. Both ends of the RS485 communication line are connected with terminals, and the terminals at both ends are connected in parallel. The length of the line shall not exceed 1000m. It is recommended to use a special shielded communication line.
- The RS485 interface of the inverter is located on the internal control board of the machine. Please distinguish "A" and "B". The wrong connection will lead to communication failure.
- If Shinemaster / Enerlog is not used for monitoring, the user's own monitoring equipment needs to be compatible with the RS485 communication protocol of ATESS.
- For the same 485 bus, only 120Ω matching resistance needs to be connected from end to end. Please set the dial switch according to the field installation.

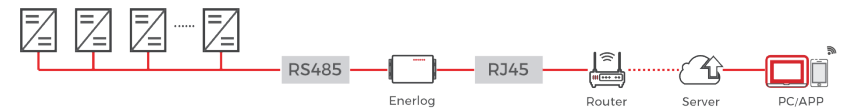

## 2. BMS-CAN communication

● When the PCS works with battery with BMS management system, it needs to communicate with BMS through CAN communication. The CAN communication interface of BMS is connected to CAN-A interface of the PCS, communication can be realized after docking the communication protocol.

● Terminals are used at both ends of the CAN communication line. The terminals at both ends are connected in parallel to make the can communication line. It is recommended to use a special shielded communication line to reduce communication interference and improve the operation stability of the system.

● The CAN-A interface is on the internal control board of the inverter. Please distinguish between "L" and "H". Incorrect connection will lead to communication failure.

● If the user does not use the BMS battery system produced by ATESS, the user's own BMS battery system needs to be compatible with the BMS communication protocol of ATESS.

● For the same CAN bus, just connect 120Ω matching resistance from end to end. Please set the dial switch according to the field installation.

1. The communication connection between the bypass cabinet and PCS is divided into CAN communication and control communication. (See Section 5.5 for can communication connection).

2. Control communication connection method: Both the bypass cabinet and the PCS have a conversion terminal block (see section 3.3.2), and the bypass cabinet is provided with a butt harness. Connect according to the digital label.

3. PCS1000HV does not have a built-in transformer, so you need to connect an external transformer when it is used with a bypass cabinet. For specific connection methods, refer to the internal transformer wiring diagram of PCS1000HV. The PCS1200HV/PCS1500HV cannot be directly equipped with bypass cabinet for switching between on-grid and off-grid modes.

## 3. Bypass cabinet- CAN communication

● When the PCS is used with the bypass cabinet, it needs to communicate with each other. The Can communication port of the bypass cabinet is connected to the CAN-B interface on PCS. Note: Only the ATESS bypass cabinet can communicate with the PCS

● ATESS bypass cabinet comes with a dedicated communication line to communicate with the inverter which is directly connected to the CAN-B interface.

● The can-A interface is on the internal control board of the PCS. Please distinguish "L" and "H". Incorrect connection leads to failure of normal communication.

● For the same CAN bus, 120Ω matching resistance needs to be connected from end to end. Configure the dial switch according to the site installation.

## 4. Solar charge controller - CAN communication

● PCS is used with Solar charge controller and needs to communicate with it, and the CAN-B communication interface of solar charge controller is connected to can-B of the PCS.

● Solar charge controller is in the same position as the communication interface of the PCS. Please distinguish "L" and "H". Incorrect connection leads to failure of normal communication.

● For the same CAN bus, 120Ω matching resistance needs to be connected from end to end. Configure the dial switch according to the site installation.

## Parallel communication (parallel customized)

● When the same PCS models connect in parallel, the parallel communication line should be connected, which is supplied along with each PCS. The parallel ports of the two PCS are connected using the parallel communication line.

The control board has two parallel ports, either one can be connected, the two ports are exactly the same.

● The dial switch 4, 5 and 6 should be switched to "ON" for the first and the last PCS in the parallel system .

● When no other device is connected to the CAN-B bus in the system, the dial switch 3 of first and the last PCS in the parallel system must also be switched to "ON". If the bus is equipped with other devices, ensure that there are resistors at each end of the bus. Set the dial switch based on the site condition.



As Parallel function is a special customized function, please use it under the guidance of ATESS staff.

## 5.6 Diesel generator dry contact wiring

The inverter has a passive dry contact contactor to control the diesel generator, and the following is the dry contact structure diagram (initial state).

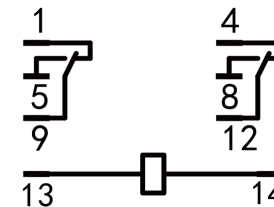

### Wiring instructions:

1. "13" and "14" are the dry contact contactor power supply, which has been connected before delivery.

2. There are two groups of dry contacts: 1, 5, and 9 are a group, and 4, 8, and 12 are a group. The two groups work simultaneously.

3. The initial state is that when the PCS does not send the command to start the DG, the state between "1" and "9" is closed, and the state between "5" and "9" is open. When the PCS sends the command to start the DG, "1" and "9" are converted from closed to open, and "5" and "9" are converted from open to closed. "4" and "8" and "12" are the same.

4. When the current needs to pass through the dry contact, the AC voltage does not exceed 240V, the DC voltage does not exceed 28V, and the current does not exceed 5A.

## 5.7 Energy storage system wiring and communication wiring

### 5.7.1 Power cable connection

PCS HV is connected to PV via the solar charge controller and connected to the high-voltage grid via the transformer.

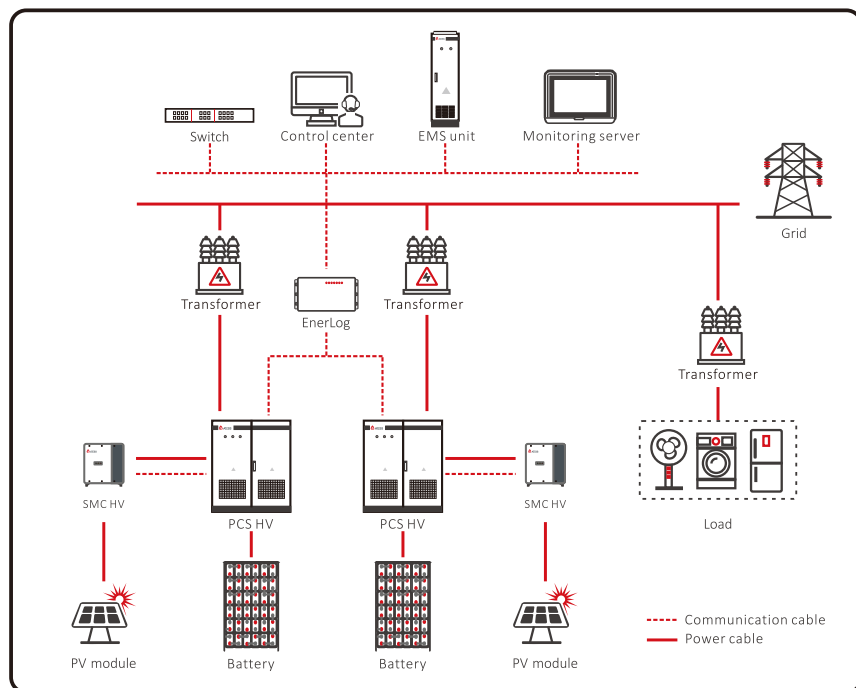

System diagram

### 5.7.2 Wire connection of parallel system and CAN communication wire

#### ● Parallel system:

1. The same PCS model is connected in parallel with the AC output supplying load at the same time, running in the same mode.
2. Parallel means when off-grid parallel, in which multiple PCS maintain the same AC frequency, amplitude and phase.

#### ● System requirements:

1. The PCS must be of the same model.
2. To ensure the stable running of the system, ensure that the configurations of each machine are consistent.
3. The parallel system needs to communicate, so all devices must be installed in adjacent positions.

#### ● Wiring instructions:

1. To reduce circulation loss, it is recommended to share batteries. If the shared battery is selected and the battery is equipped with BMS, all devices (PCS and Solar charge controller) need to communicate with the battery.
2. The parallel system is equipped with dedicated communication ports and cables to connect the communication ports of parallel devices.
3. To ensure the communication quality, the devices must be installed in the same position to reduce the communication distance. The length of the communication cable we supply is 5 meters.
4. The length of the AC cable to the convergence point on each machine must be the same; otherwise, power distribution may be unbalanced.

#### ● Working mode:

The working mode of the parallel system is the same as that of the single system, but the working mode of each device must be set to the same.

Redundancy is optional for parallel systems.

Description of redundancy function selection:

Redundancy can be selected only when one device fails and the other devices can still drive all the loads. Otherwise, the device will be overloaded.

Note: Parallel machine is a special function, standard machine may not be equipped with this function, please contact ATESS staff in advance if you need this function.

Installation requirements for parallel systems are high. Before installation, contact ATESS for installation and testing to ensure the correct operation of parallel systems.

# 6 Commissioning

## 6.1 Inspection before operation

Before the inverter is put into operation, its installation shall be inspected. At least two staff do the inspection according to the items listed below to ensure the correctness of the installation.

### Inspection items for installation

- There is no deformation or damage to the inverter.
- Bottom of the inverter is fixed securely, the foundation support is stable and reliable.
- There is enough space around the inverter.
- The temperature, humidity and ventilation conditions of the environment where the inverter is located meet the requirements.
- There is enough cooling air for ventilation.
- Cabinet sealing protection is complete and reliable

### Electrical inspection

- Inverter is grounded completely and firmly.
- The grid voltage matches the rated output voltage of the inverter.
- The phase sequence of grid connection is correct, and the tightening torque meets the requirements.
- The positive and negative poles of DC input connection are correct, and the tightening torque meets the requirements.
- Communication wiring shall be correct and keep a certain distance from other cables.
- Cable number is marked correctly and clearly.
- The insulation protection cover is complete and reliable, and the danger warning label is clear and firm.

### Other inspection

- All useless conductive parts shall be tied with insulating ties.
- There are no tools, parts, conductive dust or other foreign matters left inside the cabinet.
- There is no condensation of moisture or ice in the cabinet

## 6.2 Power on steps

Energy storage controller adopts the integrated AC and DC power supply method, and LCD can be lit when there is AC or DC alone.

### ● Battery power supply

The battery can be used for the first time power-on. When the battery breaker is closed, the LCD should be on.

### ● AC power supply

AC power supply can be used for the first time power-on. Turn on AC input switch, bypass switch, AC output switch and the micro breaks, LCD should be on. When the energy storage controller is powered by AC, as long as the battery voltage is detected to be abnormal for more than 10 minutes, all circuit breakers except bypass will be switched off, and inverter won't be able to start and operate when powered by AC source alone. After LCD is lightened by AC power supply, the bypass switch must be off before the machine turns on.

It is recommended to use batteries to light up the screen. After power on, please do not switch the power-on knob immediately. Please check the historical information page and check whether the operation setting is in line with the actual situation. Please refer to Chapter 7 for details.

# 7 GUI Instruction

## 7.1 LCD display screen introduction

User can view the information of the inverter operation on the LCD touch screen, as well as setting the operating parameters. In order to facilitate the operation, a menu is provided below.

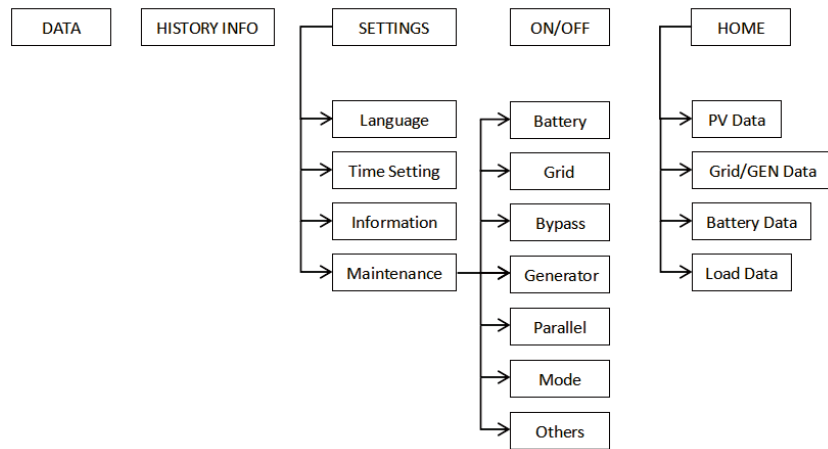

PCS LCD Menu logical structure

1. After the LCD is powered on, it enters the startup interface and home page for after 15s, but it still takes about 2 minutes to initialize. the inverter cannot be started until the initialization is completed. When √ and numbers appear, the initialization is completed.

2. At the top right of each page, The communication status between LCD and the inverter's control board (if √, the communication is normal, otherwise ×, communication failure), station number of the communication end where the inverter is located, system time, etc are displayed.

3. Five common function buttons are located at the bottom of each page:

[DATA] [HISTORY INFO] [SETTINGS] [ON/OFF] [HOME]

These buttons allow users to perform quick and convenient operations. The selected button will be highlighted in red.

## 7.2 LCD operation

### 7.2.1 Home page

Click the [HOME] button in any other interface to enter this page.

The operation data overview on this page mainly includes the device's Status, Operation Mode, Real-Time Power, BMS State, current direction, model and parallel address

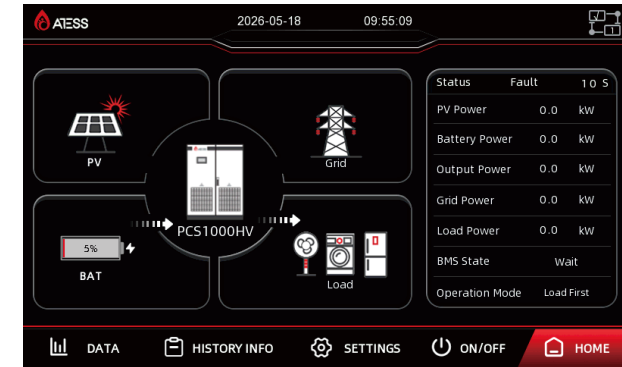

Clicking the PV, BAT, Grid/GEN, Load and PCS icons on the left side of the LCD will display the PV Data, Battery Data, Grid Data, Load Data and operation data overview windows on the right side. The grid icon will be replaced with the engine icon in the engine mode, and clicking it will display GEN Data on the right.

You can switch to other pages using the common function keys below the LCD.

Operation status	Description
Fault	Not started or failed to start
Permanent fault	Serious failure occurred
Wait	Start initialization
Check	System self checking
Off grid mode	Off grid mode with load
On Grid mode	Successfully connected to grid
PV charge	PV only charging mode
Parallel to off-grid	Parallel system waiting to enter off-grid mode
Parallel to on-grid	Parallel system waiting to enter on-grid mode

**Operation mode:** The current state of the energy storage controller will be displayed here.

**BMS state:** When the energy storage controller works with a lithium battery with BMS, the current state of the BMS will be displayed here.

### 7.2.2 ON/OFF interface

Clicking "ON/OFF" button in any interface will enter into this interface.  
 There are "ON" and "OFF" button which is used to turn on and turn off the inverter.  
 Start up: turn the start knob to on and click "on" to start up successfully.  
 Shut down: shut down by clicking "off", or turn the start / stop knob to off directly.  
 If the machine will be turned off for a long time, use the off-on knob to shut it down.

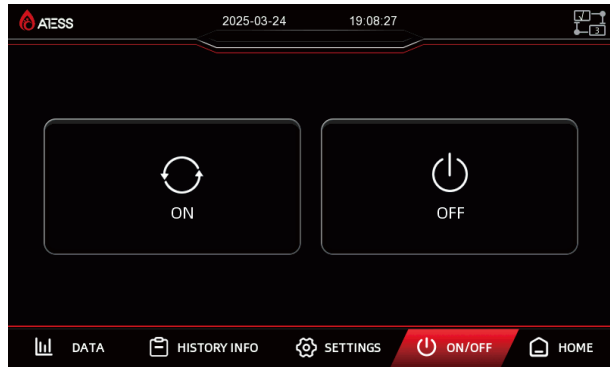

### 7.2.3 Operation data

Click [DATA] at the bottom of any other interface to enter the submenu of "operation data".  
**Operation data:** Use the page switching arrows on this page to browse different operation data, including real-time updated information such as grid, diesel generator, battery, load, temperature, power, etc.

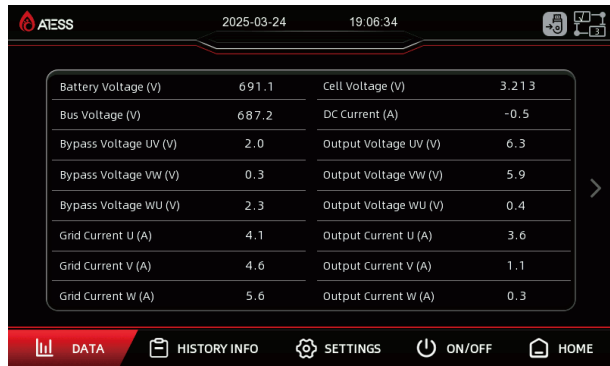

**Data export:** After inserting the USB flash drive into the interface on the back of the LCD display, click the button with the USB flash drive logo in the upper right corner of the first page of the operation data interface to export the operation data.

### 7.2.4 History Information

Click the [HISTORY INFO] button on any other interface to enter the "History information" page.



Slide the progress bar on the right up and down to view the historical fault details, and click the delete button in the upper right corner to clear the completed faults in the table.  
 For more fault information, see Appendix 7.3.

### 7.2.5 System setting

Clicking "System setting" button in any interface will enter into this interface.  
 Submenu: language settings, time settings, inverter information, maintenance. Pressing the left button can enter into the corresponding submenu interface. The default one is language setting interface.

**Language Settings:** Select language, currently it only supports Chinese, English.



**Time settings:** system time setting (if the date and time displayed on LCD is not inconsistent with the actual date and time, they can be modified here).

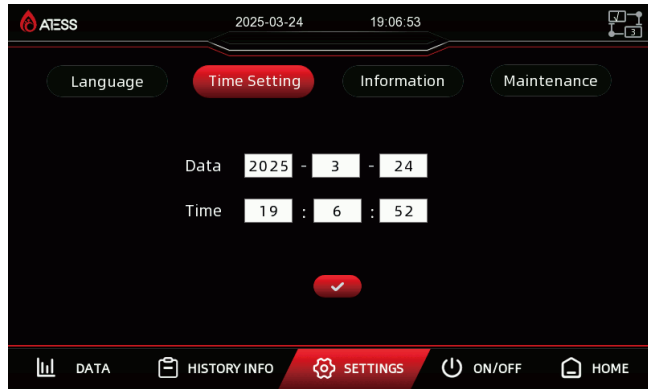

**Information:** This page shows the manufacturer, inverter serial number, hardware and software version information, and the date of manufacturing.

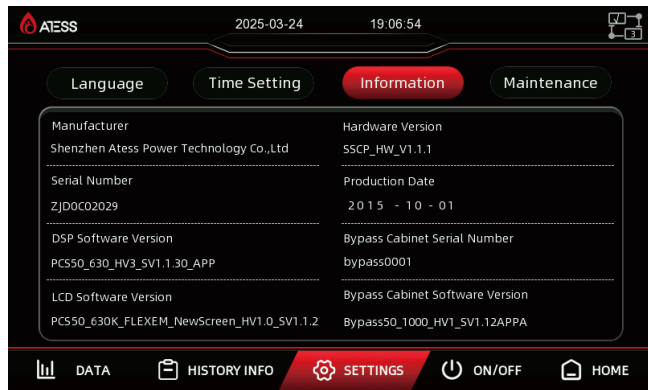

**Maintenance:** the interface requires a password to login, it is for electrician and maintenance personnel who are fully familiar with the structure and working principle of the DC grid system only, in order to avoid damage to personal safety and the inverter.

After entering the correct password, you can enter the "Device Maintenance" submenu. The submenus include: Battery parameters, Grid parameters, Bypass cabinet parameters, Generator parameters, Parallel parameters, Mode parameters, and others. Enter the corresponding interface according to the parameters that need to be modified. If you need to return to the "Device Maintenance" submenu and retain the authority, please click the [System Settings] button below once.

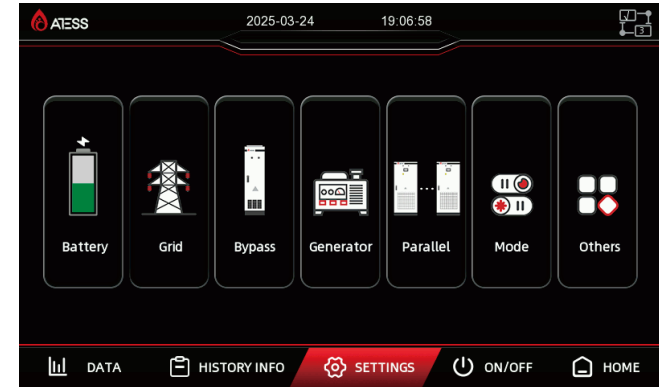

There are several reasons why the current value cannot be changed to the set value:

- LCD response is slow, you can switch pages to speed up the update.
- The value exceeds the limit and cannot be saved.

### 1. Battery Parameters

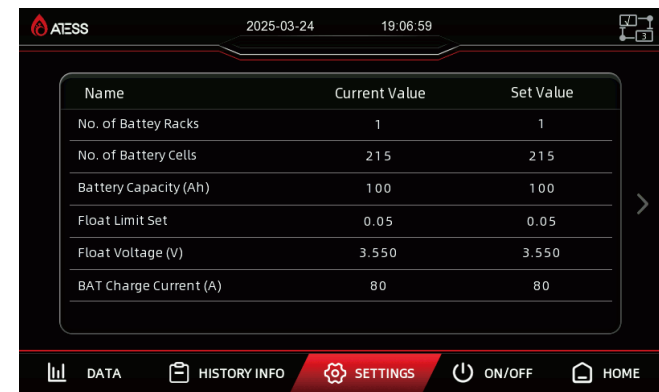

**No. of Battery Racks:** The number of battery racks connected in parallel. e.g.

2V/200Ah, 240 in series and 2 in parallel, the number of racks is 2.

**No. of Battery Cells:** The number of cells in each string of a battery. e.g. 2V/200Ah, 240 in series and 2 in parallel, the number of cells is 240.

**Battery Capacity:** Capacity of a battery group (unit: Ah), e.g. 2v/200Ah , 240 strings, 2 series then the capacity is 200Ah.

**Float limit set:** Set current limiting charging, when the current unit voltage is greater than (floating cell voltage - floating charge current limiting point), enter the current limiting charging state.

$$\text{Target charging current} = \frac{\text{floating cell voltage} - \text{current unit voltage}}{\text{floating charge current limiting point value}} * \frac{\text{battery charging current set value}}{\text{current set value}}$$

When the battery is with BMS, the charging current setting value of the battery will be compared according to the maximum charging current limit value sent by the BMS and the charging current setting value set on the screen, whichever is smaller. The real-time cell voltage of the battery will be calculated according to the maximum cell voltage sent by the BMS.

When there is no BMS, it will enter floating charge current limiting mode in the DG mode and send the instruction to shut down the DG.

**Float Charge volt(V):** Set the floating charge unit voltage of the battery. When the battery cell voltage reaches this setting value, the charging current approaches 0A. It's calculated with the maximum cell voltage sent by BMS if there is BMS, otherwise calculated with the average voltage.

**BAT Charge Current(A):** You can modify the battery charging current by changing this value. Please set it according to the actual parameters of the battery to avoid losses caused by battery overcharge. When the battery is with BMS, the BMS will send the maximum charging current limit, compare it with the charging current set on the screen, and take the smaller value for charging.

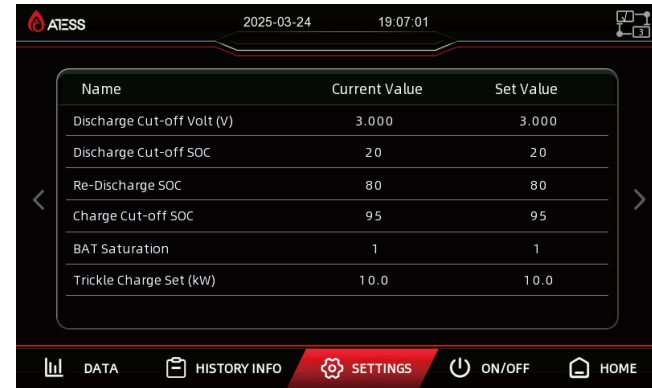

This page is for setting battery parameters. Batteries are an important part of the energy storage system. Ensure that the battery parameters are consistent with the actual situation.

**Batt-Undervolt-Warning:** When the battery voltage reaches the discharge cut-off voltage, the battery stops discharging (the battery continues to discharge until the undervoltage alarm shifts to single PV mode).

**Discharge Cut-off SOC:** When the battery is a battery with BMS and SOC reaches the set value, the energy storage controller will stop the battery discharge and only the grid-connected state will take effect; The battery does not take effect when there is no BMS, If there is no BMS, use the discharge cut-off voltage to judge.

**Re-Discharge SOC:** when the battery is with BMS, the discharge is triggered to stop the SOC and when the SOC is restored to the set value, the discharge can be continued, it only takes effect when grid-connected, if the battery has no BMS, the battery does not take effect. In this case, use the discharge saturation.

**Charge Cut-off SOC:** When the battery is with BMS, the SOC reaches the set value and stops charging, and it does not take effect when there is no BMS; This setting value and floating charge voltage take effect at the same time, whichever reaches it first takes effect.

**BAT Saturation:** Takes effect only in grid-connected mode. When the battery voltage stops discharging due to undervoltage or discharge cut-off, the battery unit voltage must reach the set value to resume discharging.

$$\text{Recovery discharge unit voltage} = \text{floating charge unit voltage} - \frac{\text{battery saturation set value}}{10}$$

This function does not take effect when the battery is lithium battery and BMS voltage judgment is not enabled on the PCS.

**Trickle Charge SET(kw):** When the discharge cut-off voltage or discharge cut-off SOC is reached, the battery is trickle-charged at this power to maintain the battery voltage and prevent the battery voltage from being too low.

Name	Current Value	Set Value
BAT UnderVolt Warning (V)	2.900	2.900
BAT UnderVolt Protect (V)	2.700	2.700
BAT OverVolt Protect (V)	3.650	3.650
BAT OC Charge Protect (A)	400.0	400.0
BAT OC Discharge Protect (A)	400.0	400.0

**Batt UnderVolt Warning(V):** Indicates the unit voltage when the battery undervoltage alarm is generated. The minimum cell voltage sent by BMS is used when BMS is present, otherwise the average voltage is used for calculation.

**BAT UnderVolt Protect(V):** The unit voltage value when the battery undervoltage protection, when the battery voltage reaches this set value, the PCS will protect and stop. The minimum cell voltage sent by BMS is used when BMS is present, otherwise the average voltage is used for calculation.

**BAT OverVolt Protect(V):** The battery over voltage unit voltage value. When the battery voltage reaches this set value, the PCS will protect and stop. The maximum cell voltage sent by BMS is used when BMS is available, otherwise, the average voltage is used for calculation.

**BAT OC Charge Protect(A):** Indicates the protection value of the total battery charging current.

**BAT OC Discharge Protect(A):** Specifies the protection value of the total discharge current of the battery.

Name	Current Value	Set Value
BMS Communication Enable	1	1
BMS Volt Judge Switch	0	0
PV Charge To Off-Grid (V)	3.200	3.200
Battery Share Enable	1	1

**BMS communication enable:** Set this parameter to 1 for BMS communication between the PCS and the battery. Otherwise, set it to 0.

**BMS Volt Judge Switch:** Set this parameter to 1 when the BMS SOC calculation accuracy is poor and system operation is affected and the single voltage is needed to determine the BMS. Otherwise, set this parameter to 0.

**PV Charge To Off-Grid(V):** In single PV mode, the battery unit voltage reaches the set value when the battery unit voltage reaches the single PV off-grid mode.

**Battery Share Enable:** Set to 1 when the batteries are shared; set to 0 when the batteries are separated.

## 2. Grid Parameters

Name	Current Value	Set Value
Max. Grid Voltage (V)	440.0	440.0
Min. Grid Voltage (V)	340.0	340.0
Max. Grid Frequency (Hz)	52.00	52.00
Min. Grid Frequency (Hz)	48.00	48.00
Output Power Limit (%)	100	100
Output Voltage (V)	400	400
Output Frequency (Hz)	50	50

**Max. Grid Voltage (V):** If it exceeds Max. power grid voltage, it will switch to off grid mode. The default setting is 110% of rated voltage.

**Min. Grid Voltage (V):** If it gets lower than Min. power grid voltage, it will switch to off grid mode. The default setting is 90% of rated voltage.

**Max. Grid Frequency(Hz):** If it exceeds Max. power grid frequency, it will switch to off grid mode.

**Min. Grid Frequency(Hz):** If it gets lower than Min power grid frequency, it will switch to off grid mode. The default setting is rated-2.

**Output Power limit(%):** AC output power percentage. It can be set to 1%-120%, the default setting is 100%, and it is recommended not to exceed 110%.

**Output Voltage(V):** The off-grid output voltage can be set to 480, and can be changed according to the actual needs. After the change, power off and restart to take effect.

**Output Frequency(Hz):** The AC output frequency can be set to 50 to 60, and can be changed according to the actual needs. After the change, power off and restart to take effect.

Name	Current Value	Set Value
Max. Import from Grid (kW)	250	250
Max. Export to Grid (kW)	10	10
Max. Grid Charge Power (kW)	250.0	250.0
Grid Charge Cutoff SOC	90	90
Grid Charge Cutoff Volt (V)	3.550	3.550
Zero Export Enable	1	1
Grid & PV Charge Enable	1	1

**Max. Import from Grid(kW):** The maximum power can be taken from the grid.

**Max. Export from Grid(kW):** The maximum power feed to the power grid, including PV, which can limit the power feed to the power grid.

**Max. Grid Charger Power(kW):** The maximum charging power of the grid to the battery can limit the charging power of the grid to the battery.

**Grid Charge Cutoff SOC:** BMS voltage judgment enable 1 or BMS communication enable 0 takes effect. When the grid power is sufficient and charging with grid power is allowed, the BMS minimum single cell voltage or battery single cell voltage is charged to the grid charging cut-off voltage at most, which is realized in battery first, economic mode valley period, and time scheduling valley period. When the grid charging cut-off SOC or grid charging cut-off voltage is reached, only PV and grid-connected inverter are used to charge the battery, and the grid does not charge the battery.

**Grid Charge Cutoff Volt:** BMS voltage judgment enable 1 or BMS communication enable 0 takes effect. When the grid power is sufficient and charging with grid power is allowed, the BMS minimum single cell voltage or battery single cell voltage is charged to the grid charging cut-off voltage at most, which is realized in battery first, economic mode valley period, and time scheduling valley period. When the grid charging cut-off SOC or grid charging cut-off voltage is reached, only PV and grid-connected inverter are used to charge the battery, and the grid does not charge the battery.

**Zero Export Enable:** Set this parameter to 1 when it is not allowed to feed electricity to the power grid. otherwise, set it to 0.

**Grid & PV Charge Enable:** When this parameter is set to 1, the power grid, DG and PV can charge the battery at the same time. PV supply is preferred, supplemented by power grid/DG when insufficient; When set to 0, the power grid/DG and PV cannot charge the battery at the same time. PV supply is preferred, and only when PV has no power will the power grid/DG charge the battery.

Name	Current Value	Set Value
Fully Zero Export Enable	0	0
Import from Grid Compensation (kW)	0.2	0.2

**Fully Zero Export Enable:** When set to 1, in load first mode, for three-phase unbalanced loads, the energy storage inverter takes the minimum load power phase \* 3 to calculate the total load. The energy storage inverter outputs the load power calculated at this time, and the excess power is supported by the grid.

**Import from Grid compensation (kW):** When in DG mode, the maximum rectifying power of the diesel generator = the set maximum power of the diesel generator + compensation power.

### 3. Bypass Cabinet Parameters

Name	Current Value	Set Value
Bypass Cabinet Enable	1	1
Bypass Cabinet Share Enable	0	0
Bypass Cabinet Com No.Enable	0	0
Bypass Cabinet Com No.	3	3
Bypass Cabinet Units	3	3
Bypass Cabinet CanA Baud Rate (kbps)	20	20
Bypass Cabinet Model Select	Bypass250	Bypass250

**Bypass Cabinet Enable:** When the PCS is used with a bypass cabinet produced by ATESS, the bypass cabinet must be enabled to 1. When using a bypass cabinet produced by other manufacturers, set it to 2 and use dry contact signal detection to distinguish between the grid and the generator (see Section 5.6 for specific operation methods).

**Bypass Cabinet Share Enable:** When the parallel system shares a bypass cabinet, set this to 1; otherwise, set this to 0. Currently, only one cabinet can be shared.

**Bypass Cabinet Com No.Enable:** When you need to set the bypass cabinet communication station number, first set the enable to 1, then modify the bypass cabinet station number. After the modification is successful, you must set the enable to 0. Only the corresponding energy storage controller and bypass cabinet should be turned on. After the setting is completed, turn off the power and set other machines to avoid repeated delivery.

**Bypass Cabinet Com No.:** This parameter is not required for single system. The parallel system is divided into two situations: 1. Each PCS is equipped with a bypass cabinet. In this case, the communication station number should be the same as the 485 address of the corresponding PCS.

2. All PCSs share one bypass cabinet and do not need to be set up.

**Bypass Cabinet Units:** Indicates the number of Bypass cabinets in the system.

**Bypass Cabinet CanA Baud Rate:** When the PCS is used with a bypass cabinet, the CANA baud rate of the bypass cabinet should be consistent with the CANB baud rate of the PCS communication. The baud rate can only be changed when the bypass cabinet communication station number enable is set to 1; the default value is 20kbps.

**Bypass Cabinet Model Select:** When PCS is used with a bypass cabinet produced by ATESS, select the corresponding bypass cabinet model through the pop-up window here.

#### 4. GEN Parameters

Name	Current Value	Set Value
GEN Enable	1	1
Max. GEN Power (kW)	250	250
Max. GEN Charge Power (kW)	50.0	50.0
GEN Off SOC	80	80
GEN On SOC	30	30
GEN Manual Control	0	0

**GEN Enable:** When the PCS grid input is connected to a diesel generator, the diesel generator enable needs to be set to 1, otherwise it needs to be set to 0. When the PCS is used with a bypass cabinet and connected to a diesel generator, both the GEN enable and the Bypass Cabinet Enable need to be turned on at the same time.

**Max. GEN Power(kW):** Takes effect in only the "DG mode" mode. It is the power upper limit of the power generator and the limit of charging + load. Note that the power upper limit of the power generator cannot be lower than the total load value.

**Max.GEN Charge Power:** The maximum charging power of the generator to the battery. The charging power of the generator to the battery can be limited.

**GEN Off SOC:** It takes effect when the GEN mode and BMS communication enable is 1. When the current SOC is greater than the generator shutdown SOC, the PCS sends a generator dry contact shutdown signal.

**GEN On SOC:** It takes effect when the GEN mode and BMS communication enable is 1. When the current SOC is lower than the generator start SOC in off-grid mode, the PCS sends a generator dry contact start signal.

**GEN Manual Control:** The function of manual switch Diesel Generator, set 1 for PCS sends a dry contact switch-on signal and set 0 for PCS sends a dry contact switch-off signal.

#### 5. Parallel Parameters

Name	Current Value	Set Value
Parallel Enable	1	1
Number of Parallel Units	3	3
Parallel Redundant Units	0	0
Parallel Address	1	1
Parallel Address Auto Switch Enable	0	0
System ID Sign	1	1

**Parallel Enable:** When it is set to 1, parallel function is enabled, All the parallel units needs to be set to 1.

**Number of Parallel Units:** Number setting of parallel system, When 2 inverters in parallel, set as 2; when three units set as 3.

**Parallel Redundant Units:** The maximum number of faults that can be supported in a parallel system. When set to 0, when any device in the parallel system fails, all devices will enter fault mode; when set to x, when the number of faults is not greater than x, other devices will continue to operate normally (the maximum number of supported faults is x).

**Parallel address:** The address of the parallel system, which cannot be repeated. The address must be set from No.1 and must be continuous; Address 1 is the host.

**Parallel Address Auto Switch Enable:** Set to 1 to enable automatic address switching, preventing duplicate addresses in parallel systems.

**System ID sign:** The server needs to distinguish whether each device is the same system and use this to collect data, Devices of the same system should be set the same non-zero number here.

#### 6. Mode Parameters

OnGrid	Current Value
Operation Mode	Time Schedule
<input type="checkbox"/> Load First	<input type="checkbox"/> Battery First
<input type="checkbox"/> Economic mode	<input checked="" type="checkbox"/> Time Schedule

The on grid modes include: Load First, Battery First, Economic mode, and time schedule. Click the box in front of the corresponding mode to select a different on grid mode.

1. The time schedule is a pure on grid mode, please use it with caution.
2. When the PCS is used with a bypass cabinet, the system selects the corresponding on grid mode or GEN mode according to whether it is connected to the grid or the generator.
3. After selecting Economy mode or Time Schedule mode, a page switch button will appear on the right. Click it to switch to the Economy mode and Time Schedule mode setting page. The settings there are only effective in these two modes.

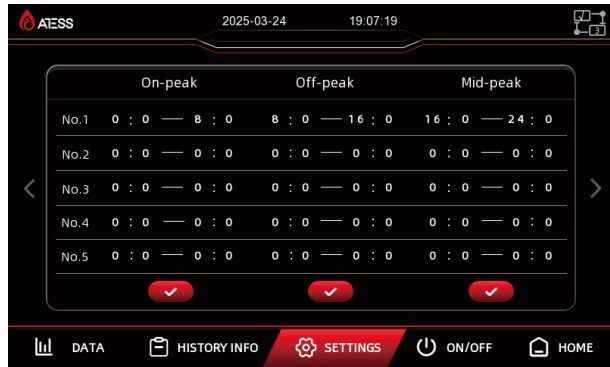

1. The start time should be before the end time.
2. The time range after 24:00 must be divided into two periods. For example, from 22:00 to 2:00, it can be divided into 22:00-24:00 and 00:0-2:00.
3. The time period that does not need to be set can be kept at 0:0-0:0. In addition, the upper time period must be earlier than the lower time period.
4. In the economic mode, only the effective time is set. The peak, valley, and fair working logic of the economic mode is implemented according to the three time periods.

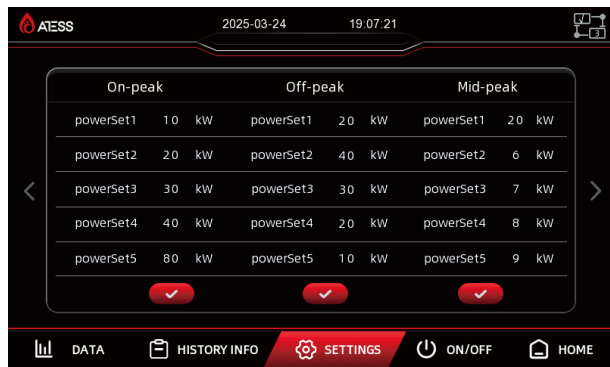

In the time schedule mode, the time setting and power setting take effect at the same time, and charging or discharging is performed at different times according to the power set in each time period.

## 7. Other

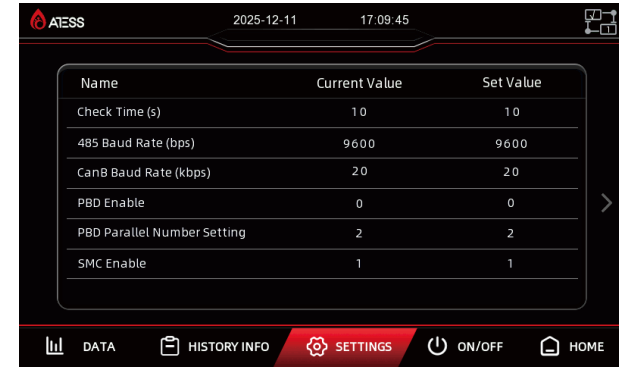

**Check Time:** The default boot detection time is 60 seconds, the minimum is 10 seconds, and the maximum is 300 seconds.

**485 Baud Rate:** RS485 baud rate of PCS.

**CanB Baud Rate:** CANB baud rate of PCS, the default value is 20K.

**PBD Enable:** Set this parameter to 1 when it is used with PBD. Otherwise, set this parameter to 0.

**PBD Parallel Number setting:** Set the number of PBDs connected to this machine.

**SMC Enable:** Set this parameter to 1 when it is used with SMC. Otherwise, set this parameter to 0.

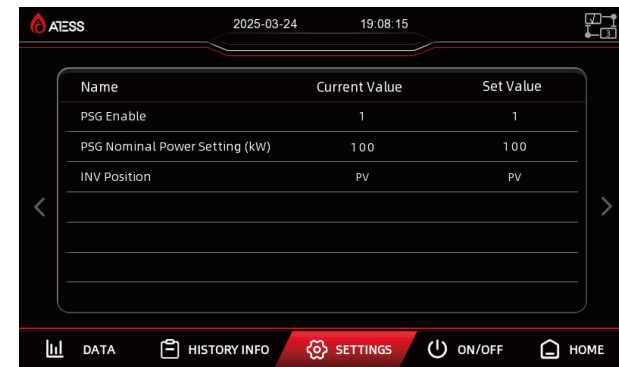

**PSG Enable:** Grid-connected inverter enabling parameters, set to 0 for disable, set to 1 for 232 to 485 communication and 485 communication, set to 2 for CAN communication.

**PSG Nominal Power Setting:** Set the rated power of the grid-connected inverter.

**INV Position:** Select the corresponding grid-connected inverter position option according to whether it is connected to the load side or the PV side.

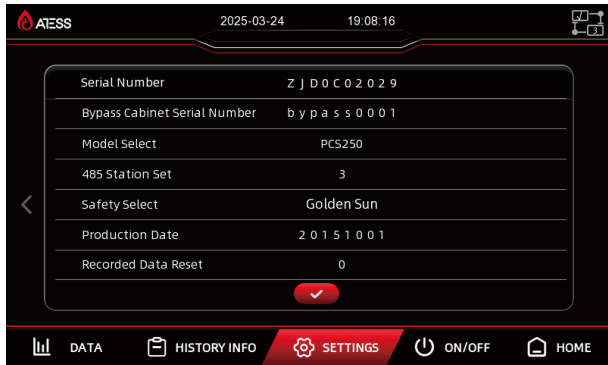

**Serial Number:** Serial number of the PCS.

**Bypass Cabinet Serial Number:** Serial number of the bypass cabinet.

**Model Select:** For PCS models, please do not modify them at ordinary times. Please modify them under the guidance of ATESS after-sales personnel.

**485 Station Set:** The 485 address of PCS.

**Safety Select:** Please do not modify the PCS safety regulations at ordinary times. Please modify them under the guidance of ATESS after-sales personnel.

**Production Date:** The production date of the PCS.

**Recorded Data Reset:** Power statistics clear function.

## 7.2.6 Customer Service Settings

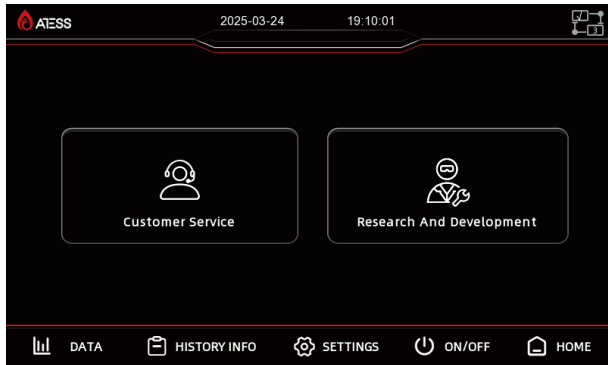

On any other interface, press and hold the upper left LOGO for about 1 second, select Customer Service Settings, and you can enter the Customer Service Settings interface.

After entering the correct password, you can enter the "Customer Service Settings" submenu.

The submenu includes: protection parameters[Protect], calibration parameters[Sample], active power regulation[P regulate], reactive power regulation[Q regulate], off-grid management[Off Grid] and protection point settings[Setting].

After entering the submenu, you will automatically enter the protection parameter setting page.

## 1. Protection Parameters

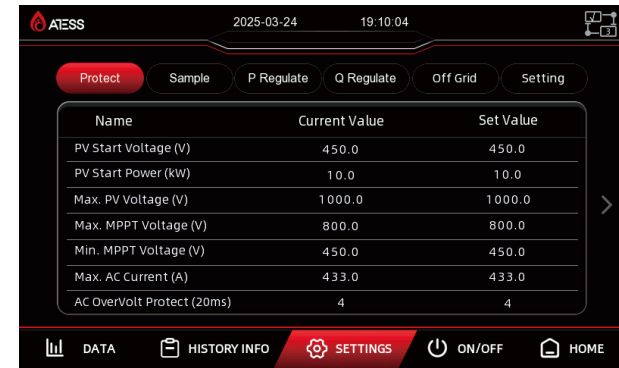

**PV Start Voltage:** MPPT tracks the starting voltage of the PV power.

**PV Start Power:** When the PV power is greater than the PV startup power, the MPPT starts tracking the maximum power.

**Max.PV Voltage:** PV voltage upper limit. If the PV voltage exceeds the upper limit, a PV voltage high fault will be reported and the PCS will shut down for protection.

**Max.MPPT Voltage:** MPPT tracks the maximum value of the PV voltage for PV power.

**Min.MPPT Voltage:** MPPT tracks the minimum PV voltage for PV power.

**Max.AC Current:** AC current upper limit. If the grid current exceeds the upper limit by 1.1 times, a high grid current fault will be reported and the energy storage controller will shut down for protection.

**AC OverVolt Protect:** Output voltage 1.2 times protection time, when PCS triggers AC overvoltage delay protection. Do not modify it at will to avoid affecting the stable operation of the system.

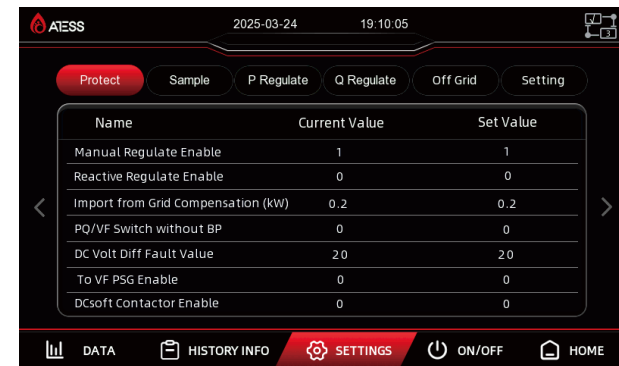

**Manual Regulate Enable:** The default value is 1. Please modify it under the guidance of ATESS after-sales personnel.

**Reactive Regulate Enable:** Set it to 1 to enable reactive power regulation mode, and set it to 0 to disable it.

**Import from Grid Compensation:** Forcefully draw power from the grid, with a maximum of 10kW.

**PQ/VF Switch without BP:** When there is no bypass cabinet, the off-grid operation is set to 0 and the on-grid operation is set to 1.

**DC Volt Diff Fault Value:** The maximum allowable voltage difference of DC soft start. If the difference between the bus voltage and the battery voltage is greater than this value, a DC soft start fault will be reported.

**To VF PSG Enable:** The limit level of the PV inverter power when switching from on-grid to off-grid. 0 means no limit, 1 means limit to the load power, and 2 means limit to 0kW.

**DCsoft Contactor Enable:** With DC auxiliary contactor set 1, otherwise set 0.

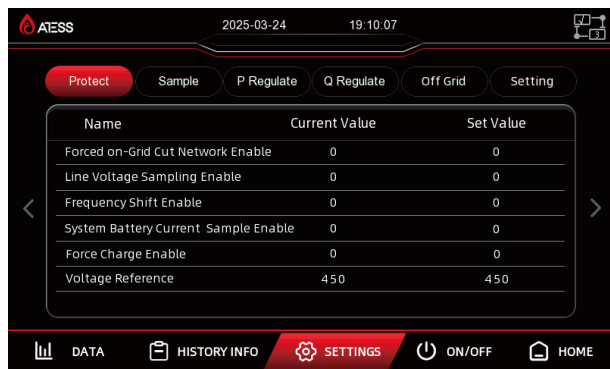

**Forced on-Grid Cut Network Enable:** Set 1 to force a switch from on-grid to off-grid.

**Line Voltage sampling Enable:** Set 1 when the output voltage is sampled directly from the line voltage.

**Frequency Shift Enable:** When set to 1, the power is controlled without communication with the PV inverter. the PCS off-grid outputs the frequency according to the demand, and the PV inverter controls the power according to the frequency.

**System Battery Current Sample Enable:** When the Hall sensor directly samples the battery current, it is set to 1; otherwise, it is set to 0.

**Force Charge Enable:** Enable to respond to forced charging of the BMS.

**Voltage Reference:** Only effective in DC source mode, set the reference voltage of the DC source.

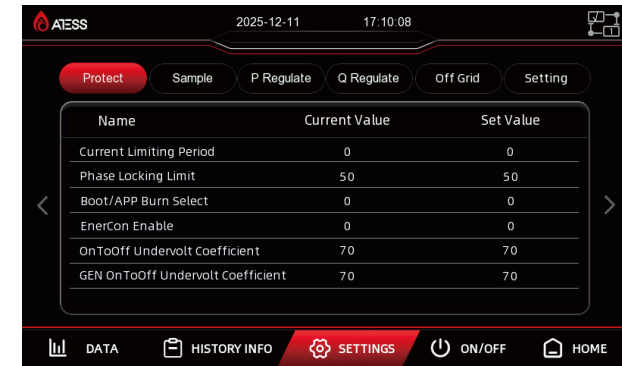

**Current Limiting Period:** The number of cycles (20MS) of current limiting triggered by the wave-by-wave current limiting will report a fault. The default value is 4.

**Phase Locking Limit:** When switching from off-grid to grid-connected phase-locking, adjust the phase-locking speed.

**Boot/APP Burn Select:** 0: Burn App; 1: Burn Boot.

**EnerCon Enable:** Collector enable: When set to 1, it communicates with the collector; when set to 0, it does not communicate with the collector.

**OnToOff Undervolt Coefficient:** The multiple of the grid undervoltage condition for switching to off-grid is set to 100 by default, which is 0.7 times the rated voltage.

**GEN OnToOff Undervolt coefficient:** The multiple for the generator undervoltage condition to switch to off - grid mode is set to 100 by default, which is 0.7 times the rated voltage. This is an important setting parameter for off - grid switching. Please do not modify it by yourself and make modifications under the guidance of ATESS after - sales personnel.

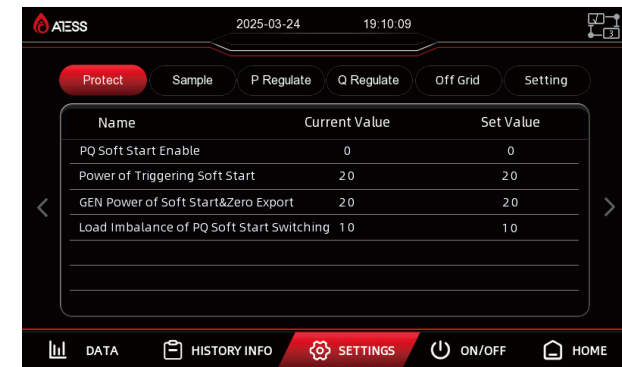

**PQ Soft Start Enable:** 0: No soft start; 1: Generator soft start; 2: On grid [and generator] soft start.

**Power of Triggering soft start:** The soft start function will be activated when the load power exceeds this value.

**GEN Power of Soft Start&Zero Export:** Set the load power of the generator for off-grid mode to GEN mode or GEN mode to off-grid mode to prevent backflow.

**Load Imbalance of PQ Soft Start Switching:** When the load imbalance is greater than this value, the soft start enters another control logic.

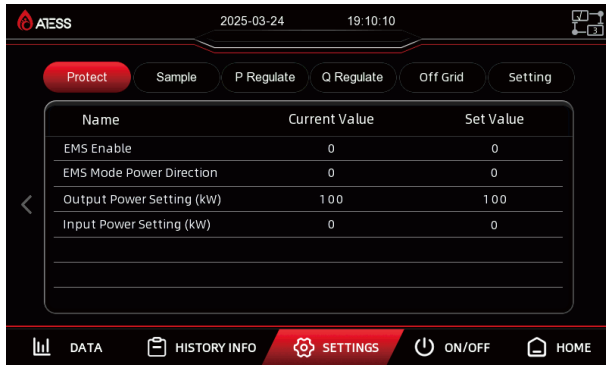

**EMS Enable:** Set to 1 to run EMS mode, set to 0 to exit EMS mode.

**EMS Mode Power Direction:** System charge/discharge selection in EMS mode, 0 is inverter, 1 is rectifier.

**Output Power Setting:** Output (inverter) power in EMS mode.

**Input Power Setting:** Input (rectified) power in EMS mode.

## 2. Calibration Parameters

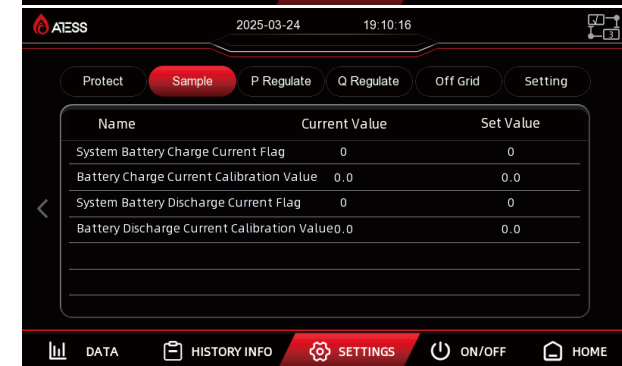
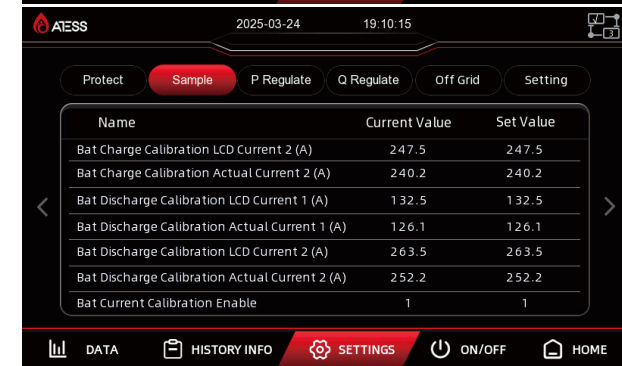
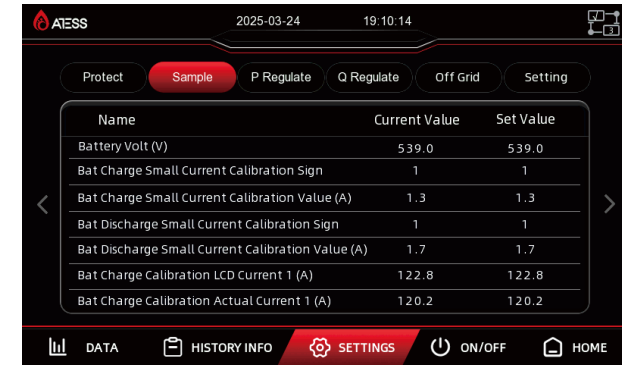
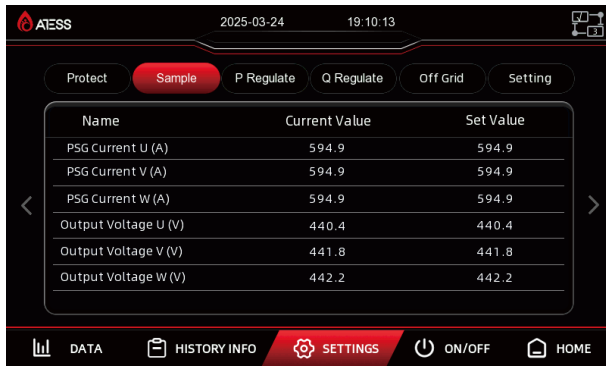
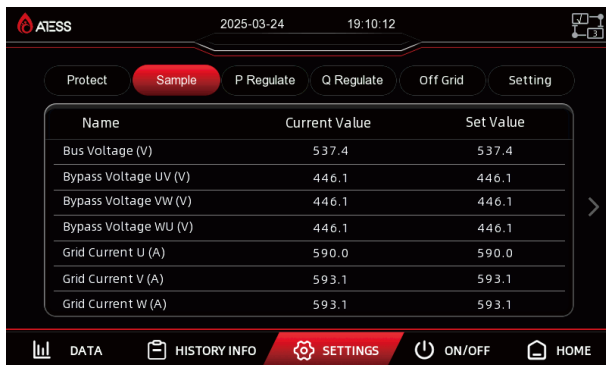

**Bat Current Calibration Enable:** When calibrating the battery current, the battery current calibration enable should be kept at 0. After changing the battery calibration, set this enable to 1 to activate the calibration effect.

The other parameters on these pages are important setting parameters and should not be modified under normal circumstances. Please modify them under the guidance of ATESS after-sales personnel.

### 3. Active Power Regulation

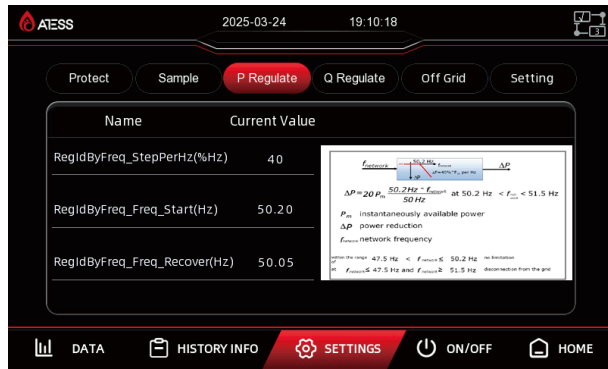

The parameters on this page are important setting parameters, please do not modify them in normal times, please modify them under the guidance of ATESS after-sales personnel.

### 4. Reactive Power Regulation

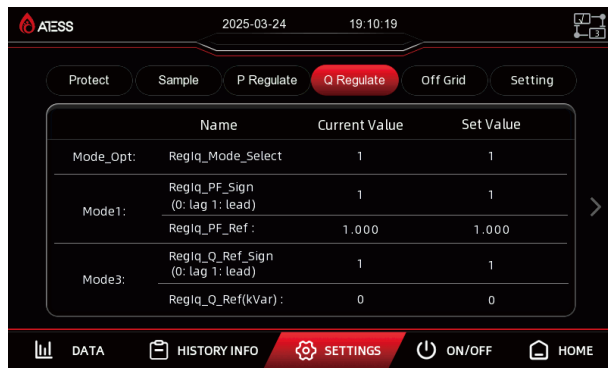

- Mode\_opt:Reglq\_Mode\_Select: Reactive power regulation mode selection, 0-4.
- Mode 1: Reglq\_PF\_Sign: Power factor compensation direction, 0 is lagging and 1 is leading.
- Mode 1: Reglq\_PF\_Ref: Power factor compensation.
- Mode 3: Reglq\_Q\_Sign: Reactive power compensation direction, 0 is lagging, 1 is leading.
- Mode 3: Reglq\_Q\_Ref: Grid reactive power compensation power reference value.

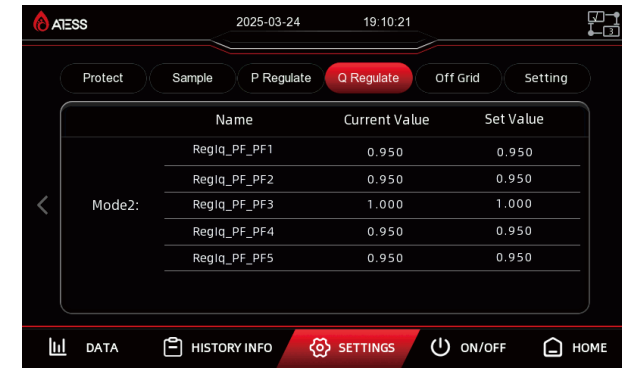
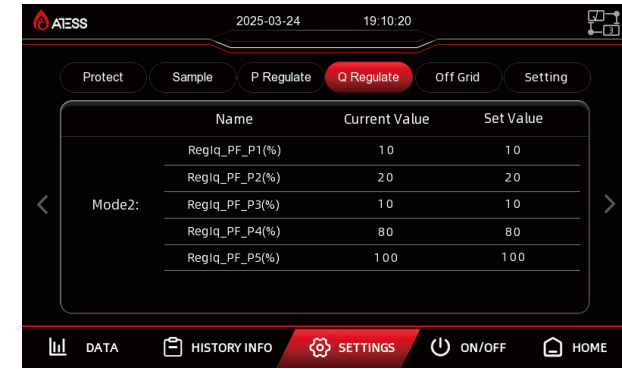

The parameters on these pages are important setting parameters, please do not modify them in normal times, please modify them under the guidance of ATESS after-sales personnel.

### 5. Off-grid Management

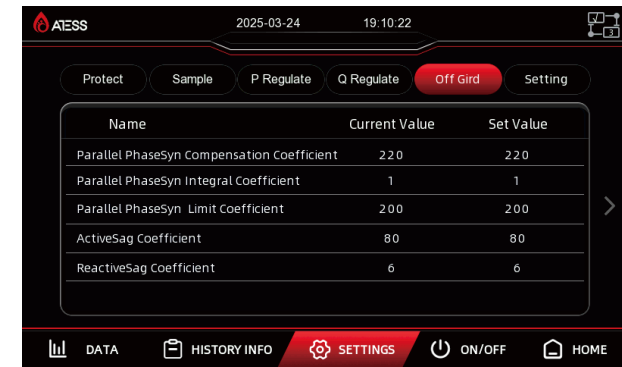

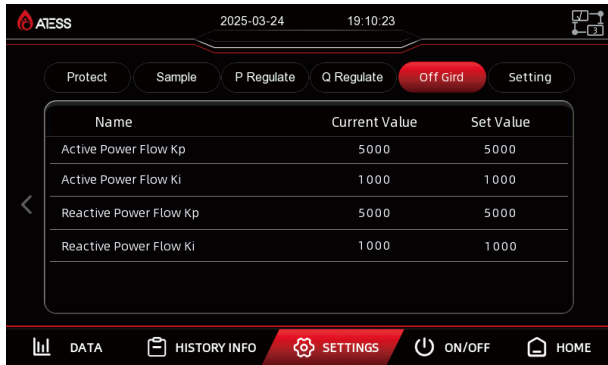

The parameters on these pages are important setting parameters, please do not modify them in normal times, please modify them under the guidance of ATESS after-sales personnel.

## 6. Protection Point Settings

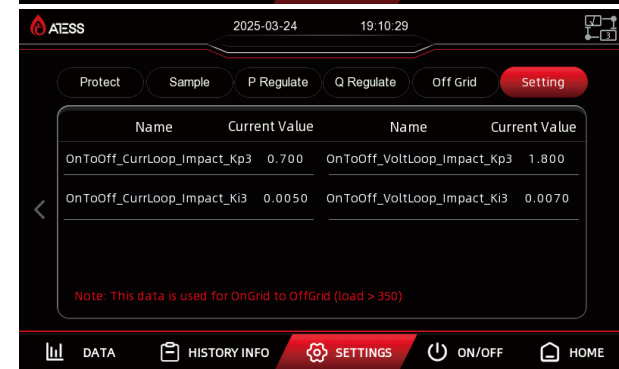
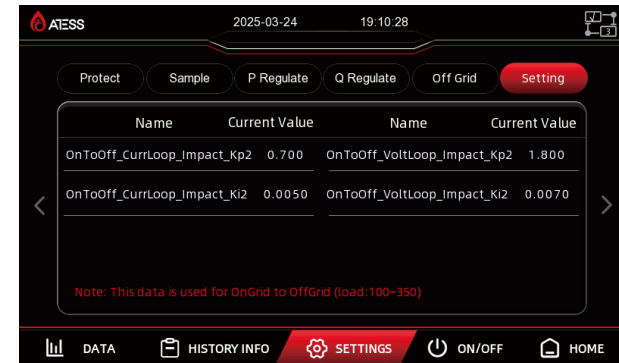
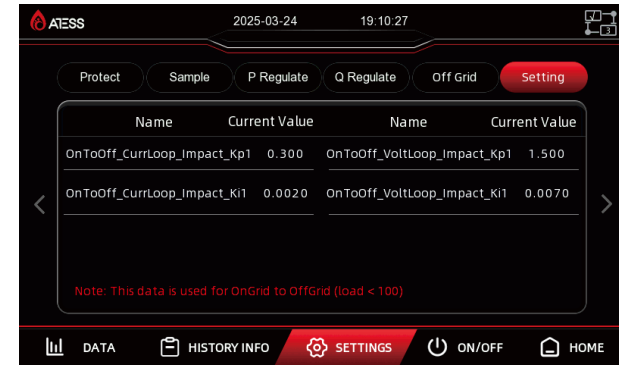
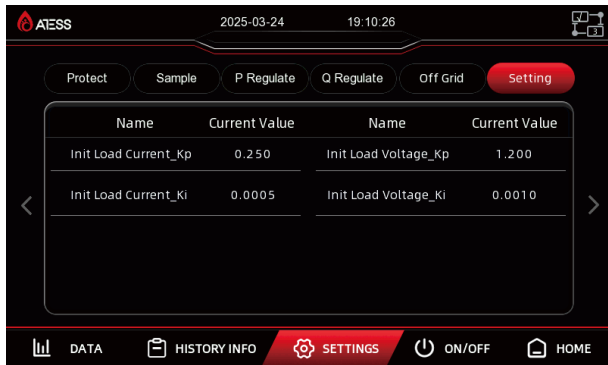
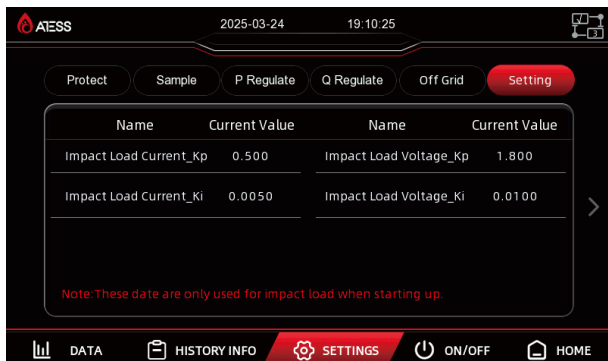

The parameters on these pages are important setting parameters, please do not modify them in normal times, please modify them under the guidance of ATESS after-sales personnel.



The page without instructions is the factory preset parameter, please do not modify. If the subsequent scheme changes, please modify the parameters under the guidance of ATESS.

### 7.3 LCD display information schedule

General history failure table

No	Information	
	English	Chinese
1	IGBT_Failure	IGBT永久故障
2	EEPROM_Write_Failure	EEPROM写永久故障
3	EEPROM_Read_Failure	EEPROM读永久故障
4	AC_MainContactor_Failure	主接触器永久故障
5	AC_SlaveContactor_Failure	辅助接触器永久故障
6	Bypass_Communication_Fault	旁路柜通信故障
7	BMS_Communication_Fault	BMS通信故障
8	BMS_Fault	BMS故障
9	Smoke_alarm_Fault	烟雾报警故障
10	PBD250_Communication_Fault	PBD250通讯故障
11	IGBT_Converter_Fault	变流器IGBT故障
12	Converter_L_OCP_Fault	变流器电感过流故障 (Trip)
13	AC_NoUtility_Fault	交流无市电故障
14	AC_GridPhaseSeque_Fault	交流电网相序反故障
15	AC_Volt_Unbalance_Fault	交流电压不平衡故障
16	AC_Wu_OverVolt_Fault	交流WU过压故障
17	AC_Wu_UnderVolt_Fault	交流WU欠压故障
18	AC_VW_OverVolt_Fault	交流VW过压故障
19	AC_VW_UnderVolt_Fault	交流VW欠压故障
20	AC_UV_OverVolt_Fault	交流UV过压故障
21	AC_UV_UnderVolt_Fault	交流UV欠压故障
22	AC_OverFreq_Fault	交流过频故障
23	AC_UnderFreq_Fault	交流欠频故障
24	GridCurr_High_Fault	电网电流高故障
25	Converter_LCurr_High_Fault	变流器电感过流故障 (RMS)
26	AC_Overload_Fault	过载故障
27	Converter_Module_OverTemp_Fault	变流器模块过温故障
28	Converter_L_OverTemp_Fault	变流器电感过温故障
29	Transformer_OverTemp_Fault	变压器过温故障
30	LowTemp_Fault	低温故障
31	EPO_Stop	紧急停机
32	KeyEmergencyStop	手动关机
33	LcdEmergencyStop	LCD关机
34	AC_MainContactor_Fault	交流主接触器故障
35	DC_MainContactor_Fault	直流主接触器故障

No	Information	
	English	Chinese
36	AC_SlaveContactor_Fault	交流辅助接触器故障
37	AC_Thunder_Fault	交流防雷器故障
38	DC_SoftStart_Fault	DC软启故障
39	INV_SoftStart_Fault	交流软启故障
40	INT_ConverterL_OverCurr_Fault	变流器电感过流故障 (INT)
41	Batt_OverVolt_Fault	电池过压故障
42	Batt_UnderVolt_Fault	电池欠压故障
43	Batt_OverCurr_Fault	电池过流故障
44	Batt_OverCharge_Fault	电池过充故障
45	Fault_Feedback_Warning	故障反馈告警
46	Temp_Derating_Warning	过温减载告警
47	Bstt_UnderVlt_Warning	电池欠压告警
48	Parallel_Uneven_Flow_Warning	并机不均流告警
49	CANb_Communication_Fault	CANb通信故障
50	Parallel_PLL_Signal_Fault	并机锁相同步信号故障
51	Parallel_Switch_Signal_Fault	并机切换同步信号故障
52	PV_Module_OverTemp_Fault	平衡板过温故障
53	INT_Bus_Unbalance_Fault	母线不平衡 (INT) 故障
54	BusVolt_Unbalance_Fault	母线不平衡故障
55	BL_OCP_Fault	平衡板硬件过流 (Trip)
56	INT_BL_OverCurr_Fault	平衡板电流过流故障
57	INV_A_OCP_Fault	A电感过流故障 (Trip)
58	INV_B_OCP_Fault	B电感过流故障 (Trip)
59	INV_C_OCP_Fault	C电感过流故障 (Trip)
60	BAT1_OverCurr_Fault	电池1过流故障
61	BAT2_OverCurr_Fault	电池2过流故障
62	GFDI_AirSwitch_Fault	GFDI空开回检异常

## 7.4 General troubleshooting

If there is a fault during the operation, please click the LCD "history information" page to view the fault information. The following are the common fault analysis and solutions of PCS:

1. Manual shutdown: turn PCS panel knob to "off"

solution: the knob is shut down normally, no need to handle.

2. LCD emergency stop: click "off" on PCS screen

Processing steps: the screen is shut down normally, no need to handle.

3. Emergency stop: emergency stop button pressed.

Handling steps: release the emergency stop button in case of no other abnormalities.

4. Batt\_UnderVolt\_Fault:

Possible reasons:

a. The battery voltage sampled on the screen reaches the under-voltage protection condition and triggers it.

b. The switch of battery on battery side or the on the energy storage controller is not turned on.

c. If this fault occurs during operation, the battery voltage may be pulled down due to high-power output, or the battery itself may be defective.

d. If it is a battery with BMS, this fault will also occur if the lowest cell voltage of the battery unit transmitted by the BMS to the energy storage controller reaches the protection condition.

Processing steps:

a. First, check the battery connection, screen sampling error, and battery parameter settings.

b. If it is a battery with BMS, check whether the BMS data meets the protection conditions.

c. If there is no problem with the above, please contact ATESS for assistance.

5. Batt\_OverVolt\_Fault:

Possible reasons:

a. The battery voltage sampled on the screen reaches the overvoltage protection trigger condition.

b. If it is a battery with BMS, this fault will also occur if the highest cell voltage of the battery unit transmitted by the BMS to the energy storage controller reaches the trigger protection condition.

7. Batt\_OverCurr\_Fault: the battery discharge current is higher than the maximum discharge current

Processing steps: check whether the maximum discharge current value of the battery is reasonable, multiply the maximum discharge current by the battery voltage, calculate the maximum discharge power of the battery, see whether it is less than the load power, if yes, reduce the load power.

8. BMS\_Fault: secondary or tertiary battery failure

Processing steps:

A. check the specific faults reported by BMS

B. contact the battery manufacturer to solve the problem

C. restart after troubleshooting

9. BMS\_Communication\_Fault: the energy storage inverter did not receive CAN data sent by battery BMS

Processing steps:

A. check whether the CAN line of ATS is connected to the CAN-A port of the inverter's control board.

B. check if the L and H CAN line are connected reversely.

C. check whether the CAN line is interfered. Suggest to use sampling shielded communication line.

D. use the CAN box to check whether there is data sent by the BMS on the bus.

E. if the communication still fails, contact ATESS.

10. Bypass\_Communication\_Fault: the energy storage inverter did not receive can data sent by bypass cabinet

Processing steps:

A. check whether the CAN line of ATS is connected to the CAN-B port of the inverter's control board.

B. check whether the L and H CAN line is connected reversely

C. check whether the CAN line is interfered. Suggest to use sampling shielded communication line.

D. use CAN box to check if there is data sent by ATS on the bus.

E. if communication still fails, contact ATESS.

11. AC\_NoUtility\_Fault: no AC voltage.

Processing steps: generally, this fault will not fade out because there is no output due to other reasons.

12. AC\_OverFreq\_Fault: the power grid frequency exceeds the upper limit, and the energy storage inverter enters off grid state.

Processing steps: check whether the upper limit of power grid frequency is reasonable. If yes, wait until it returns to normal, the inverter will automatically enter into grid connection state.

13. AC\_UnderFreq\_Fault: the power grid frequency is lower than the lower limit, and the energy storage inverter enters the off grid state.

Processing steps: check whether the lower limit of power grid frequency is reasonable. If yes, wait until the power grid frequency returns to normal, PCS will automatically enter into grid connection state.

14. AC\_UV\_OverVolt\_Rmt\_Warning: when the utility grid voltage is higher than the upper limit, the energy storage inverter enters off grid state.

Processing steps: check whether the upper limit setting of power grid voltage is reasonable. If yes, wait until the power grid voltage returns to normal, and PCS will automatically enter into grid connection state.

15. AC\_VW\_OverVolt\_Rmt\_Warning: when the grid voltage is higher than the upper limit, PCS enters off grid state.

Processing steps: check whether the upper limit setting of power grid voltage is reasonable. If yes, wait until the power grid voltage returns to normal, and PCS will automatically enter into grid connection state.

16. AC\_WU\_OverVolt\_Rmt\_Warnin: when the grid voltage is higher than the upper limit, PCS enters off grid state.

Processing steps: check whether the upper limit setting of power grid voltage is reasonable. If yes, wait until the power grid voltage returns to normal, and PCS will automatically enter into grid connection state.

17. AC\_UV\_UnderVolt\_Rmt\_Warning: when the grid voltage is lower than the lower limit, PCS enters off grid state.

Processing steps: check whether the lower limit setting of power grid voltage is reasonable. If yes, wait for the power grid voltage to return to normal, and PCS will automatically enter into grid connection state.

18. AC\_VW\_UnderVolt\_Rmt\_Warning: when the grid voltage is lower than the upper limit voltage, PCS enters off grid mode.

Processing steps: check whether the lower limit setting of power grid voltage is reasonable. If yes, wait for the power grid voltage to return to normal, and PCS will automatically enter into grid connection state.

19. AC\_WU\_UnderVolt\_Rmt\_Warning: when the grid voltage is lower than the upper limit voltage, PCS enters off grid state.

Processing steps: check whether the lower limit setting of power grid voltage is reasonable. If yes, wait for the power grid voltage to return to normal, and PCS will automatically enter into grid connection state.

20. AC\_GridPhaseSeque\_Fault: reverse phase sequence connection of power grid

Processing steps: check the three lines of phase sequence U V W of the utility grid, which are corresponding to A B C connected to the AC input terminal of inverter.

21. OverTemp\_Fault: the temperature inside of the machine is too high.

Processing steps:

A. check whether the power supply micro break of the inverter is turned on. If not, turn it on.

B. check whether PCS air inlet and outlet are blocked, and clean dust regularly.

C. wait for the machine to cool down, the fault is eliminated and inverter restart normally, and observe whether the fan works when the temperature reaches 60 °C. If not, please contact ATESS.

Regarding other faults, please contact relevant professionals of ATESS.

## 8.1 Power on steps

After installation and system settings are inspected, inverter can be started for operation.

### ● First run

The first operation steps are as follows:

1. Turn on the PV, battery, AC input and power supply micro breaks.
2. Check whether the screen sampling data is abnormal and consistent with the actual situation;
3. After checking, turn the knob to "on", click "on" on the LCD "on / off" page, and wait for the machine to enter "grid connection"; if the site is off grid, it will enter "off grid mode" after starting;
4. During operation, observe whether the data displayed on the screen is normal and whether there is fault information reported, and whether the machine has abnormal noise and smell; if any abnormal situation occurs, please stop the machine immediately for inspection.



### Warning!

The bypass switch is only used for maintenance. Please do not turn it on during normal operation.

### Manual shutdown

1. After clicking the LCD shutdown button to shut down the machine manually, it must be turned on manually through the start button (on) on the LCD; if the machine is turned off by turning the knob to "off", turn the PCS knob to "on" first, and then click the "on" button on the LCD "switch on" page to start the machine, otherwise inverter cannot start automatically.



### Warning!

The machine is still with electricity after manual shutdown.

## 8.2 Pilot operation completion

The following procedures shall be carried out after the inverter is normally in operation.

Procedure 1: Inspect whether abnormality exists in the inverter, such as excessive noise, excessive heat, abnormal smell or smoke.

Procedure 2: Measure whether inverter voltage, current and THD are stable.

Procedure 3: Operate LCD control panel and inspect whether it displays normally and accurately.

Procedure 4: Test whether it conforms to the preset operation logic.

By now, the pilot operation of inverter is fully completed, and we can enter the daily operational maintenance.

## 8.3 Power off steps



### CAUTION!

After the inverter is completely powered off, the general DC switch at battery side and the Grid switch at grid side still maintain voltage. If operations are needed, please be sure to cut off the outer power completely, and wait for not less than 5 minutes.

1. Turn the knob switch to "OFF" to shut down
2. Disconnect the AC general input switch
3. Disconnect the DC output switch

It is normal that the PCS generates an alarm during the power-off. You can continue to perform the power-off steps.

## 9.1 Regular maintenance







Due to the influence of environment temperature, humidity, dust and vibration, the devices inside the inverter will be aged and worn, which will lead to potential failure inside the machine. Therefore, it is necessary to carry out daily and regular maintenance to ensure its normal operation and service life. All measures and methods to help the inverter in good working condition belong to the scope of maintenance work.

### 9.1.1 Safety precautions

- (1) Only qualified and authorized personnel can maintain the inverter.
- (2) When carrying out maintenance work, do not leave the screws, washers and other metal parts in the inverter, otherwise the equipment may be damaged.
- (3) If only the circuit breaker is opened, the cable connection terminal inside the inverter is still electrified.
- (4) Before opening the cabinet door and starting the formal maintenance work, it is necessary to not only disconnect the circuit breaker, but also disconnect the front and rear level circuit breakers of the inverter.
- (5) After the inverter stops operation, please wait at least 5 minutes before operating.
- (6) Disconnect all external connections of the inverter and the internal power supply of the equipment.
- (7) Ensure that the inverter is not inadvertently recharged.
- (8) Use a multimeter to ensure that the inverter is completely electrically neutral inside.
- (9) Make necessary grounding and short circuit connections.
- (10) Use insulating material cloth to cover the parts near the operation part that may be electrified.

### 9.1.2 System Maintenance

Tools to be used during maintenance

	Cell phone that can take photos
	Multimeter
	Thermometer
	Pen and paper
	Spanner, screwdriver etc
	Thermal imager

When doing maintaining inspection records, you need to perform inspection one by one according to the table and describe the faulty items.

### 9.1.2.1 Maintenance and inspection checklist for running system

When recording inspection and maintenance, inspection shall be carried out one by one following the table sequence, and the faulty items shall be described accordingly.

Please refer to Capture 10.3 Maintenance and inspection checklist for non-shutdown system.

After the inspection record is completed, photos of the operation status in home page and historical information page shall be taken for record, as shown in the following figures:

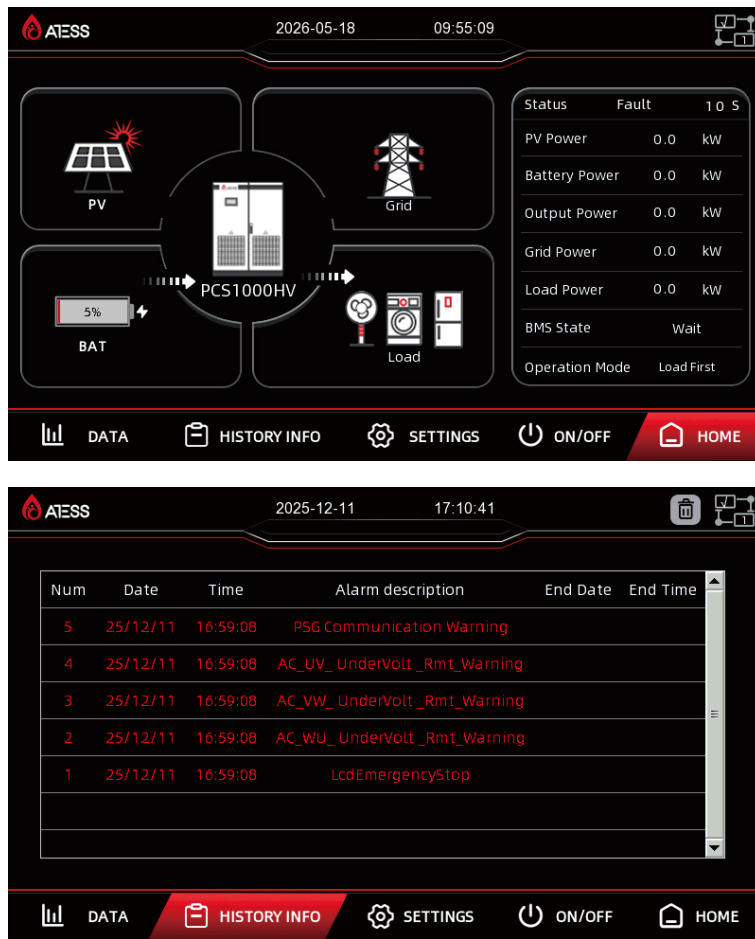

### 9.1.2.2 Maintenance and inspection checklist for shutdown system

Please refer to Capture 10.4 Maintenance and inspection checklist for shutdown system.

### 9.1.3 Relative operations



#### CAUTION!

All maintenance operations must be carried out in the condition that DC side and AC side of the inverter, PV module and AC distribution cabinet switch are all disconnected. Maintenance must be proceeded only after AC and DC disconnected for at least 5 minutes, in order to avoid electric shock!

Only professional technicians familiar with the system operation can perform such operation.

#### Disconnect the circuit breaker

Operate the DC switch of PV input and battery input to disconnect PCS from the PV and battery. And operate AC input and AC output switches to disconnect PCS from AC sources. Make sure that PCS won't switch on accidentally. Test with a multimeter to make sure the device is disconnected and with zero voltage. Even if PCS has been disconnected from the grid / main power supply, battery and PV, some of the internal components (such as capacitors) still have residual voltage and discharge slowly, so please wait at least 5 minutes after the circuit breaker is disconnected and use the multimeter to measure and confirm the safety before continuing operation.

#### Maintain and modify

Only ATESS authorized personnel can maintain and modify the equipment. For personal safety, use only the original accessories provided by the manufacturer. If you use non-original parts, you cannot ensure compliance with relevant certification standards in terms of electrical safety and EMC.

#### How to use bypass switch

If the PCS fails and cannot continue to operate, it needs to be shut down for maintenance, while the load connected to the PCS needs to continue working, the bypass switch can be used to keep the load work uninterruptedly under the power supply of power grid or generator, and the maintenance personnel can carry out maintenance work safely.

Step 1: turn on the bypass switch in case of machine failure.

Step 2: turn off the switches of "AC input", "AC output", "PV input" and "battery input". At this time, the AC and DC power are disconnected from PCS, and the load is all supplied by the power grid, after the residual power is discharged, maintenance work can be carried out.

## 10.1 Specification

Note:

1. After power off, wait for 5 minutes to confirm safety before carrying out maintenance work.
2. Use the multimeter to ensure safety before disassembling and other work.

Function and safety parameters

Do not change parameters of PCS without the authorization of the local power supply company and the instruction of ATESS. Unauthorized change of functional safety parameters may cause injury to personnel or inverter damage, in this case, ATESS will not provide warranty services.

Replace the dust screen

During the use of PCS, the dust on the top shall be cleaned regularly, and the dust screen at the air inlet shall be cleaned or replaced. During the cleaning, PCS needs to be power-off.

Replacement method of dust screen: the dust filter cotton on the door panel can be directly pulled up for cleaning and replacement.



To ensure the normal operation of the machine, clean the air filter regularly. Not cleaning for a long time may affect the intake air volume and cause overheat.

## 9.2 Waste disposal

The inverter will not cause environmental pollution, since the all the components meet the requirements of environmental protection. According to environmental protection requirements, user shall dispose the inverter in accordance with the relevant laws and regulations.

Model	PCS1000HV	PCS1200HV	PCS1500HV
<b>AC(Grid-connected)</b>			
Apparent power	1000KVA	1200KVA	1500KVA
Rated power	1000KW	1200KW	1500KW
Rated voltage	400V	550V	690V
Rated current	1445A	1260A	1260A
Voltage range	360V-440V	495V-605V	621V-759V
Rated frequency	50/60Hz		
Frequency range	45-55 /55-65Hz		
THDI	<3%		
PF	0.9lagging-0.9leading		
AC connection	3/ PE		
<b>AC(off-grid)</b>			
Apparent power	1000KVA	1200KVA	1500KVA
Rated power	1000KW	1200KW	1500KW
Rated voltage	400V	550V	690V
THDU	≤2% linear		
Rated frequency	50/60Hz		
Overload capability	110%-10min 120%-1min		
<b>DC(battery)</b>			
Rated power	1000KW	1200KW	1500KW
Current regulation	±1%		
Voltage regulation	±1%		
Voltage ripple	<3%		
Current ripple	<2%		
Voltage range	900V-1500V	900V-1500V	1000V-1500V
Maximum charge/discharge current	1111A/1111A	1111A/1334A	1300A/1500A
<b>General Information</b>			
Maximum efficiency	98.5%		
Protection degree	IP20		
Noise emission	65dB(A)@1m		
Environmental temperature	-25°C to +55°C		
Cooling	Forced air		
Relative humidity	0-95% non-condensing		
Maximum altitude	5000m(derate over 3000m)		
Dimension(W/D/H)	1510*890*2100mm		
Weight	1524kg		
Transformer	No external isolation transformer required		
On/Off grid transfer	Manual(default)Automatic(optional)≤10ms		
<b>Communication</b>			
Display	Touch screen		
Communication interface	RS485/CAN		

## 10.2 Inductive Load Conditions

### 10.2.1 AC Coupling Solution(Hybrid Solution)

When the PCS series is equipped with motor loads (such as water pumps, air conditioners, compressors, etc.), the following conditions must be met:

1. The total motor load rated power is not greater than half(50%) of the PCS rated power, and the maximum operating power is not greater than the PCS rated power;
2. When the rated power of a single motor is greater than 10KW or greater than one-eighth of the rated power of the equipment, a VFD is required.

	PCS1000HV	PCS1200HV	PCS1500HV
Single Motor required VFD power(KW)	10	10	10
Total allowable power of motors(KW)	500	600	750
The total maximum operating power allowed by the motor(KW)	1000	1200	1500

### 10.2.2 DC Coupling Solution(New Solution)

When the PCS series is equipped with motor loads (such as water pumps, air conditioners, compressors, etc.), the following conditions must be met:

1. The total motor load rated power is not greater than 70% of the PCS rated power, and the maximum operating power is not greater than the PCS rated power.
2. When the rated power of a single motor is greater than 10KW or greater than one-eighth of the rated power of the equipment, a VFD is required.

	PCS1000HV	PCS1200HV	PCS1500HV
Single Motor required VFD power(KW)	10	10	10
Total allowable power of motors(KW)	700	840	1050
The total maximum operating power allowed by the motor(KW)	1000	1200	1500

### 10.2.3 VFD requirements

1. According to the specifications of mainstream VFD such as Inovance VFD: voltage range -15%~+10%, frequency range 47HZ~53HZ/57HZ~63HZ, overcurrent 1.5 times rated current 60S protection.

### 10.2.4 Voltage drop time

1. Meet the above requirements within 20ms.

## 10.3 ATESS Factory warranty

### ● Warranty period

The warranty period of this product is one year. If otherwise specified in the contract, the contract shall prevail.

During the warranty period, the customer shall show the invoice and date of purchase to the service personnel of ATESS. At the same time, the nameplate mark on the product shall be clear and visible, otherwise, ATESS has the right not to provide warranty service.

### ● Warranty conditions

In the event of failure during the warranty period, ATESS will repair or replace the product free of charge; The customer shall Set aside some time to repair the faulty machine.

### ● Liability exemption

In case of the following circumstances, ATESS has the right not to conduct warranty:

1. Products without logo of ATESS Power Technology logo.
2. The product or component that has exceeded the valid warranty period of ATESS.
3. Failure or damage (such as high temperature, low temperature, too wet or dry, high altitude, unstable voltage or current, etc.) caused by working in beyond-specified environment or wrong installation, storage or use that violates the instructions.
4. Failure or damage caused by unauthorized installation, repair, modification or disassembly. except for those authorized by ATESS.
5. Failure or damage caused by using components that not supplied by ATESS.
6. Failure, damage or transportation damage caused by accident or human factors (operation error, scratching, carrying, bumping, improper voltage connection etc.).
7. Failure or damage caused by force majeure (such as earthquake, lightning, fire etc.).
8. Failures or damages caused by other factors rather than quality problems of the supplied product itself(including components).

### 10.5 Maintenance and inspection checklist for running system

No.	Category	Check item	Check method	Standard	Result	Problem description	Check frequency
1		Whether the LCD display of the machine is in normal operation	Visual inspection	Operation status display is not "fault" or "serious fault"	<input type="checkbox"/> Normal <input type="checkbox"/> Abnormal		
2		Whether there is error recorded in history that caused shutdown	Visual inspection	No error caused shutdown	<input type="checkbox"/> Normal <input type="checkbox"/> Abnormal		
3		Whether the data transmission of monitoring device is normal	Monitoring web page / APP	Monitoring connection and data transmission are normal	<input type="checkbox"/> Normal <input type="checkbox"/> Abnormal		Once a month
4	System operation status check	Whether the fan rotates normally and the air outlet is normal (first check whether the temperature collected by the equipment reaches the fan opening condition, which normally is 60 °C)	Visual inspection Thermal imager	Normal rotation, normal air output	<input type="checkbox"/> Normal <input type="checkbox"/> Abnormal		
5		Whether the equipment has abnormal smell or sound	Smell, listen	No abnormal sound or smell	<input type="checkbox"/> Normal <input type="checkbox"/> Abnormal		
6		Emergency stop button (when the system is in standby mode)	Manual	The circuit breaker trips after pressing the emergency stop button	<input type="checkbox"/> Normal <input type="checkbox"/> Abnormal		

### 10.6 Maintenance and inspection checklist for shutdown system

No.	Category	Check item	Check method	Standard	Result	Problem description	Check frequency
1	System cleaning	Whether there is water leakage or other foreign matters in the room or container	Visual inspection	No water leakage or foreign matter	<input type="checkbox"/> Normal <input type="checkbox"/> Abnormal		Once a month
2		Whether there are rodents and insects such as rats, geckos, cockroaches and ants in the cabinet	Visual inspection	No animals or insects	<input type="checkbox"/> Normal <input type="checkbox"/> Abnormal		
3	System cable connection (power-off inspection)	Whether the power cable connection is loose	Manual /wrench	No looseness	<input type="checkbox"/> Normal <input type="checkbox"/> Abnormal		
4		Whether the communication cable connection is loose	Manual bolt driver	No looseness	<input type="checkbox"/> Normal <input type="checkbox"/> Abnormal		
5		Check equipment ground connection	Visual inspection/ Multimeter	<=4Ω	<input type="checkbox"/> Normal <input type="checkbox"/> Abnormal		Once a month
6		whether the external connection of the equipment is damaged	Visual inspection	No damage	<input type="checkbox"/> Normal <input type="checkbox"/> Abnormal		
7	Internal cleaning	whether there is moisture or condensation inside the cabinet	Visual inspection	No condensation no moisture	<input type="checkbox"/> Normal <input type="checkbox"/> Abnormal		
8		Whether there is obvious dust inside the cabinet	Visual inspection	No obvious dust	<input type="checkbox"/> Normal <input type="checkbox"/> Abnormal		
9		Whether the front and rear dust screens has blockage	Visual inspection	No blockage	<input type="checkbox"/> Normal <input type="checkbox"/> Abnormal		
10		Whether there is obvious damage inside the equipment	Visual inspection	No damage	<input type="checkbox"/> Normal <input type="checkbox"/> Abnormal		Once a month
11		whether there is obvious rust inside the cabinet	Visual inspection	No rust	<input type="checkbox"/> Normal <input type="checkbox"/> Abnormal		
12		Safety signs	Visual inspection	Safety signs are not shed	<input type="checkbox"/> Normal <input type="checkbox"/> Abnormal		

Note: the table only indicates the recommended maintenance frequency of the product. The actual frequency shall be determined according to the specific installation environment. The scale of power station, location and site environment will affect the maintenance frequency. If the operation environment is windy and dusty, it is necessary to shorten the period and increase the frequency.